

Soft-start and quick exhaust valves MS-SV, MS series

FESTO



Festo core product range
Covers 80% of your automation tasks

Worldwide:

Always in stock

Superb:

Festo quality at an attractive price

Easy:

Reduces procurement and storing complexity

★ Generally ready for shipping ex works in 24 hours
Held in stock in 13 service centres worldwide
More than 2200 product

★ Generally ready for shipping ex works in 5 days
Assembled for you in 4 service centres worldwide
Up to 6×10^{12} variants per product series

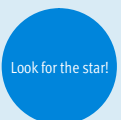

MS series service unit components

Key features



MS series service unit components

Solutions for every application

With its large product range, highly functional components and a wide choice of services, the MS series from Festo offers a complete concept for compressed air preparation. Suitable for simple standard applications as well as application-specific solutions to the highest quality standards.

Available as individual components, pre-assembled combinations ex-stock, application-specific combinations or complete turnkey solutions. The five sizes in the MS series achieve maximum flow rates with minimum space requirements.

Freely combinable function modules

Pressure regulators, on/off and soft-start valves with safety function, filter, pressure and flow sensors, dryers, sensors and lubricators. All these allow a suitable solution to be assembled for every task. Their modular structure means that the components

are freely combinable. A simple connection system saves time when replacing individual modules without dismantling the entire combination. What's more, many of the components are certified to UL and ATEX.

CAD models and configurator

Convenient aids for planning and selecting application-specific individual devices and combinations. The product configurator lets you configure customised solutions quickly and transfer the order data with no hassle.

Engineering tools

Selection tool for choosing the right service unit without oversizing, and with the right air quality class:
 → www.festo.com/engineering/wartungseinheit



Integrated sensors

Pressure and flow sensors



- Maximum machine availability through controlled processes
- Reliable compressed air preparation and supply for systems
- Integrable or stand-alone
- Easy to connect with M8/M12 plug

Safety functions

Soft-start/quick exhaust valves
 MS6-SV/MS9-SV



- Fast and reliable exhausting of systems up to Performance Level e, certified to EN ISO 13849-1
- Integrated soft-start function

Energy savings

Service units MSE6



- Fully automatic monitoring and regulation of compressed air supply
- Automatic shut-off of the compressed air in stand-by mode
- Detection and notification of leakages
- Condition monitoring of relevant process data

Intelligent mix of sizes



- Optimum flow rate with up to 18% smaller size
- Excellent energy efficiency
- Cost-optimised combinations – save up to 30%!

Size differences					
Size	MS2	MS4	MS6	MS9	MS12
Grid dimension [mm]	25	40	62	90	124
Port sizes	M5, QS-6	G1/8, G1/4, G3/8	G1/4, G3/8, G1/2, G3/4	G1/2, G3/4, G1, G1 1/4, G1 1/2	G1, G1 1/4, G1 1/2, G2
Standard nominal flow rate qnN ¹⁾ [l/min]	350	1800	6500	20000	22000

1) Using pressure regulator MS-LR as an example

MS series service unit components

Key features

Note
Information

The next few pages provide a brief overview of the complete product range for the MS series service unit components.

You can find detailed information and all of the technical data in the documentation for the corresponding service unit component.

Accessories such as connection plates or mounting brackets can be ordered either via the configurator or separately.





Structure of a service unit

The order of the individual components within a service unit is relevant for safety and functionality. It is not possible to assemble the service unit components in any order in the flow direction. There are restrictions and rules.

The configurator for service unit MSB is a reliable and convenient way of arranging individual service unit components. This ensures that the applicable rules are complied with. As a result, you get a completely assembled combination with UL or ATEX certification if you need it. When arranging a combination of individually configured and ordered service unit components, the points on the right must be adhered to under all circumstances.

- Regulators MS-LFR/LR/LRP/LRE are only permissible in the flow direction with the same or decreasing pressure regulation range
- Filters MS-LFR/LF/LFM/LFX are only permissible in the flow direction with an increasing grade of filtration
- Lubricators MS-LOE are not permitted in the flow direction upstream of a filter MS-LFR/LFM/LF/LFX, water separator MS-LWS or membrane air dryer MS-LDM1
- A micro filter MS-LFM must be installed upstream of an activated carbon filter MS-LFX or membrane air dryer MS-LDM1 in the flow direction
- A flow sensor SFAM cannot be installed directly downstream of a regulator MS-LFR/LR; a branching module MS-FRM must be positioned between them
- A soft-start/quick exhaust valve MS-SV must be the last service unit component in the flow direction





Total product range for MS series service unit components

Type	Description	Size	Pneumatic connection					
			Push-in connector	Female thread			Connection plate with thread	
				M	G	NPT	G	NPT
Combinations								
Service units MSB-FRC Technical data → Internet: msb								
	Combinations of filter regulator and lubricator	4	-	-	1/8, 1/4	-	-	-
		6	-	-	1/4, 3/8, 1/2	-	-	-
Service units MSB Technical data → Internet: msb								
	7 combinations, predefined	4	-	-	1/4	-	-	-
		6	-	-	1/2	-	-	-
	Combinations freely configurable	4	-	-	1/8, 1/4	-	1/8, 1/4, 3/8	1/8, 1/4, 3/8
		6	-	-	1/4, 3/8, 1/2	-	1/4, 3/8, 1/2, 3/4	1/4, 3/8, 1/2, 3/4
		9	-	-	3/4, 1	3/4, 1	1/2, 3/4, 1, 1 1/4, 1 1/2	1/2, 3/4, 1, 1 1/4, 1 1/2
Service units MSE6 Technical data → Internet: mse6								
	Combinations with fieldbus connection for measuring pressure, flow rate and consumption	6	-	-	-	-	1/2	-

MS series service unit components







Key features

FESTO

Total product range for MS series service unit components								
Type	Description	Size	Pneumatic connection					
			Push-in connector	Female thread			Connection plate with thread	
				M	G	NPT	G	NPT
Individual devices								
Filter regulators MS-LFR							Technical data → Internet: ms-lfr	
	Filter and pressure regulator in a single device, grade of filtration 5 or 40 µm	2	QS-6	M5	–	–	–	–
		4	–	–	1/8, 1/4	–	1/8, 1/4, 3/8	1/8, 1/4, 3/8
		6	–	–	1/4, 3/8, 1/2	–	1/4, 3/8, 1/2, 3/4	1/4, 3/8, 1/2, 3/4
		9	–	–	3/4, 1	3/4, 1	1/2, 3/4, 1, 1 1/4, 1 1/2	1/2, 3/4, 1, 1 1/4, 1 1/2
		12	–	–	–	–	1, 1 1/4, 1 1/2, 2	–
Filters MS-LF								
							Technical data → Internet: ms-lf	
	Grade of filtration 5 or 40 µm	4	–	–	1/8, 1/4	–	1/8, 1/4, 3/8	1/8, 1/4, 3/8
		6	–	–	1/4, 3/8, 1/2	–	1/4, 3/8, 1/2, 3/4	1/4, 3/8, 1/2, 3/4
		9	–	–	3/4, 1	3/4, 1	1/2, 3/4, 1, 1 1/4, 1 1/2	1/2, 3/4, 1, 1 1/4, 1 1/2
		12	–	–	–	–	1, 1 1/4, 1 1/2, 2	–
Fine and micro filters MS-LFM								
							Technical data → Internet: ms-lfm	
	Grade of filtration 0.01 or 1 µm	4	–	–	1/8, 1/4	–	1/8, 1/4, 3/8	1/8, 1/4, 3/8
		6	–	–	1/4, 3/8, 1/2	–	1/4, 3/8, 1/2, 3/4	1/4, 3/8, 1/2, 3/4
		9	–	–	3/4, 1	3/4, 1	1/2, 3/4, 1, 1 1/4, 1 1/2	1/2, 3/4, 1, 1 1/4, 1 1/2
		12	–	–	–	–	1, 1 1/4, 1 1/2, 2	–
Activated carbon filters MS-LFX								
							Technical data → Internet: ms-lfx	
	For removing liquid and gaseous oil particles	4	–	–	1/8, 1/4	–	1/8, 1/4, 3/8	1/8, 1/4, 3/8
		6	–	–	1/4, 3/8, 1/2	–	1/4, 3/8, 1/2, 3/4	1/4, 3/8, 1/2, 3/4
		9	–	–	3/4, 1	3/4, 1	1/2, 3/4, 1, 1 1/4, 1 1/2	1/2, 3/4, 1, 1 1/4, 1 1/2
		12	–	–	–	–	1, 1 1/4, 1 1/2, 2	–
Water separators MS-LWS								
							Technical data → Internet: ms-lws	
	Remove condensed water from compressed air, maintenance-free	6	–	–	1/4, 3/8, 1/2	–	1/4, 3/8, 1/2, 3/4	1/4, 3/8, 1/2, 3/4
		9	–	–	3/4, 1	3/4, 1	1/2, 3/4, 1, 1 1/4, 1 1/2	1/2, 3/4, 1, 1 1/4, 1 1/2
		12	–	–	–	–	1, 1 1/4, 1 1/2, 2	–

MS series service unit components







Key features

Total product range for MS series service unit components								
Type	Description	Size	Pneumatic connection					
			Push-in connector	Female thread			Connection plate with thread	
				M	G	NPT	G	NPT
Individual devices								
Pressure regulators MS-LR Technical data → Internet: ms-lr								
	For setting the required operating pressure, 4 pressure regulation ranges	2	QS-6	M5	–	–	–	–
		4	–	–	1/8, 1/4	–	1/8, 1/4, 3/8	1/8, 1/4, 3/8
		6	–	–	1/4, 3/8, 1/2	–	1/4, 3/8, 1/2, 3/4	1/4, 3/8, 1/2, 3/4
		9	–	–	3/4, 1	3/4, 1	1/2, 3/4, 1, 1 1/4, 1 1/2	1/2, 3/4, 1, 1 1/4, 1 1/2
		12	–	–	–	–	1, 1 1/4, 1 1/2, 2	–
Pressure regulators MS-LRB Technical data → Internet: ms-lrb								
	For creating a regulator manifold with independent pressure regulation ranges. Pressure output is to the front or rear.	4	–	–	1/4	–	1/8, 1/4, 3/8	–
		6	–	–	1/2	–	1/4, 3/8, 1/2, 3/4	–
Precision pressure regulators MS-LRP Technical data → Internet: ms-lrp								
	For precise setting of the required operating pressure, 4 pressure regulation ranges, pressure hysteresis 0.02 bar	6	–	–	1/4, 3/8, 1/2	–	1/4, 3/8, 1/2, 3/4	1/4, 3/8, 1/2, 3/4
Precision pressure regulators MS-LRPB Technical data → Internet: ms-lrpb								
	For configuring a regulator manifold with independent pressure regulation ranges. Pressure output is to the front or rear.	6	–	–	1/2	–	1/4, 3/8, 1/2, 3/4	–
Electrical pressure regulators MS-LRE Technical data → Internet: ms-lre								
	Electrically adjustable pressure regulator, 4 pressure regulation ranges	6	–	–	1/4, 3/8, 1/2	–	1/4, 3/8, 1/2, 3/4	1/4, 3/8, 1/2, 3/4
Lubricators MS-LOE Technical data → Internet: ms-loe								
	Add a precisely adjustable amount of oil to the compressed air. The oil mist component is proportional to the compressed air flow rate.	4	–	–	1/8, 1/4	–	1/8, 1/4, 3/8	1/8, 1/4, 3/8
		6	–	–	1/4, 3/8, 1/2	–	1/4, 3/8, 1/2, 3/4	1/4, 3/8, 1/2, 3/4
		9	–	–	3/4, 1	3/4, 1	1/2, 3/4, 1, 1 1/4, 1 1/2	1/2, 3/4, 1, 1 1/4, 1 1/2
		12	–	–	–	–	1, 1 1/4, 1 1/2, 2	–

MS series service unit components





Key features



Total product range for MS series service unit components								
Type	Description	Size	Pneumatic connection					
			Push-in connector	Female thread			Connection plate with thread	
				M	G	NPT	G	NPT
Individual devices								
On/off valves MS-EM Technical data → Internet: ms-em								
	Manually operated on/off valve for pressurising and exhausting pneumatic installations.	4	–	–	1/8, 1/4	–	1/8, 1/4, 3/8	1/8, 1/4, 3/8
		6	–	–	1/4, 3/8, 1/2	–	1/4, 3/8, 1/2, 3/4	1/4, 3/8, 1/2, 3/4
		9	–	–	3/4, 1	3/4, 1	1/2, 3/4, 1, 1 1/4, 1 1/2	1/2, 3/4, 1, 1 1/4, 1 1/2
		12	–	–	–	–	1, 1 1/4, 1 1/2, 2	–
On/off valves MS-EE Technical data → Internet: ms-ee								
	Solenoid actuated on/off valve for pressurising and exhausting pneumatic installations.	4	–	–	1/8, 1/4	–	1/8, 1/4, 3/8	1/8, 1/4, 3/8
		6	–	–	1/4, 3/8, 1/2	–	1/4, 3/8, 1/2, 3/4	1/4, 3/8, 1/2, 3/4
		9	–	–	3/4, 1	3/4, 1	1/2, 3/4, 1, 1 1/4, 1 1/2	1/2, 3/4, 1, 1 1/4, 1 1/2
		12	–	–	–	–	1, 1 1/4, 1 1/2, 2	–
Soft-start valves MS-DL Technical data → Internet: ms-dl								
	Pneumatically actuated soft-start valve for slowly pressurising and exhausting pneumatic installations.	4	–	–	1/8, 1/4	–	1/8, 1/4, 3/8	1/8, 1/4, 3/8
		6	–	–	1/4, 3/8, 1/2	–	1/4, 3/8, 1/2, 3/4	1/4, 3/8, 1/2, 3/4
		12	–	–	–	–	1, 1 1/4, 1 1/2, 2	–
Soft-start valves MS-DE Technical data → Internet: ms-de								
	Solenoid actuated soft-start valve for slowly pressurising and exhausting pneumatic installations.	4	–	–	1/8, 1/4	–	1/8, 1/4, 3/8	1/8, 1/4, 3/8
		6	–	–	1/4, 3/8, 1/2	–	1/4, 3/8, 1/2, 3/4	1/4, 3/8, 1/2, 3/4
		12	–	–	–	–	1, 1 1/4, 1 1/2, 2	–
Soft-start/quick exhaust valves MS-SV Technical data → Internet: ms-sv								
	For building up pressure gradually and reducing pressure quickly and safely in pneumatic piping systems. Up to category 1, PL c.	6	–	–	1/2	–	1/4, 3/8, 1/2, 3/4	1/4, 3/8, 1/2, 3/4
		9	–	–	3/4, 1	3/4, 1	1/2, 3/4, 1, 1 1/4, 1 1/2	1/2, 3/4, 1, 1 1/4, 1 1/2
	Up to category 3, PL d. Up to category 4, PL e in the case of optional extension.	6	–	–	1/2	–	1/4, 3/8, 1/2, 3/4	1/4, 3/8, 1/2, 3/4
	Up to category 4, PL e.	6	–	–	1/2	–	1/4, 3/8, 1/2, 3/4	–

MS series service unit components

Key features

Total product range for MS series service unit components								
Type	Description	Size	Pneumatic connection					
			Push-in connector	Female thread			Connection plate with thread	
				M	G	NPT	G	NPT
Individual devices								
Membrane air dryers MS-LDM1							Technical data → Internet: ms-ldm	
	Wear-free membrane dryer with internal air consumption	4	-	-	1/8, 1/4	-	1/8, 1/4, 3/8	1/8, 1/4, 3/8
		6	-	-	1/4, 3/8, 1/2	-	1/4, 3/8, 1/2, 3/4	1/4, 3/8, 1/2, 3/4
Branching modules MS-FRM								
							Technical data → Internet: ms-frm	
	Compressed air distributor with 4 connections	4	-	-	1/8, 1/4	-	1/8, 1/4, 3/8	-
		6	-	-	1/4, 3/8, 1/2	-	1/4, 3/8, 1/2, 3/4	-
		9	-	-	3/4, 1	3/4, 1	1/2, 3/4, 1, 1 1/4, 1 1/2	1/2, 3/4, 1, 1 1/4, 1 1/2
		12	-	-	-	-	1, 1 1/4, 1 1/2, 2	-
Distributor blocks MS-FRM-FRZ								
							Technical data → Internet: ms-frm-frz	
	Compressed air distributor with 4 connections and half the grid dimension width	4	-	-	-	-	-	-
		6	-	-	-	-	-	-
Flow sensors SFAM								
							Technical data → Internet: sfam	
	For absolute flow rate information and accumulated air consumption measurement	6	-	-	-	-	1/2	1/2
		9	-	-	-	-	1, 1 1/2	1, 1 1/2

New

MS...-10V24C/10V24D/10V24E/10V24F

Soft-start and quick exhaust valves MS6-SV-C, MS series

Peripherals overview

FESTO

Soft-start and quick exhaust valve MS6-SV-C

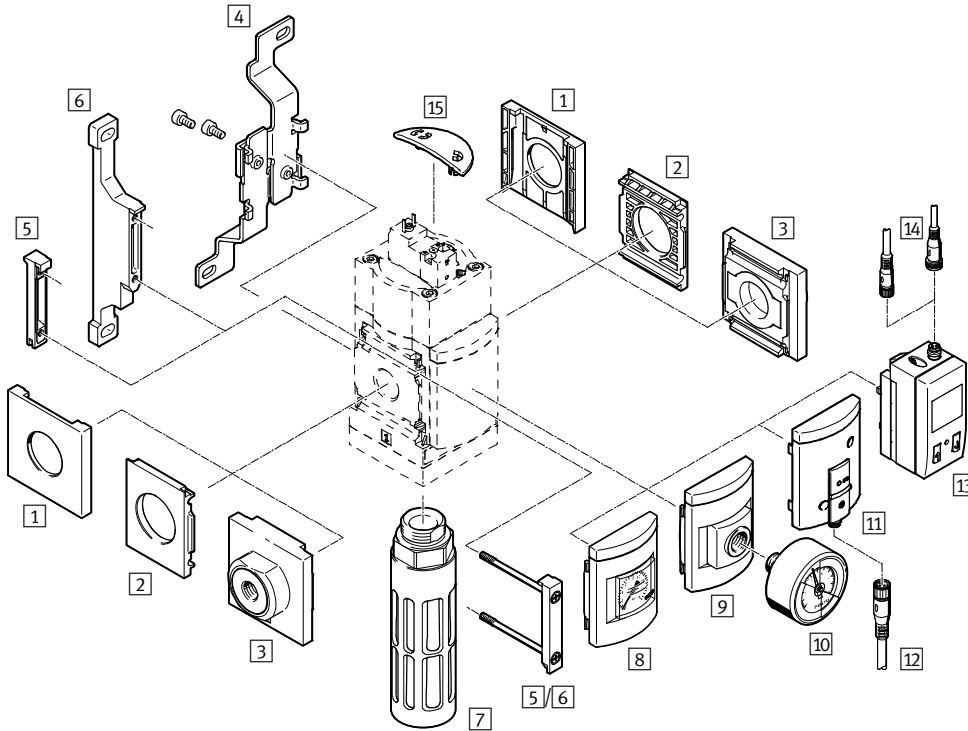

Note

Additional accessories:

- Module connector for combination with size MS4/MS6 or size MS9 → Internet: amv, rmv, armv
- Adapter plate for mounting on profiles → Internet: ipm-80, ipm-40-80, ipm-80-80

Supply voltage
10V24/10V24C

Supply voltage
10V24D/10V24E/10V24F/10V24P

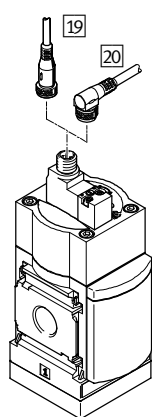
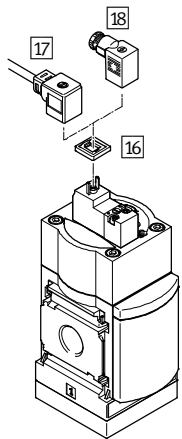

Soft-start and quick exhaust valves MS6-SV-C, MS series

Peripherals overview

Mounting attachments and accessories						
		Individual device		Combination		→ Page/Internet
		Without connecting plate	With connecting plate	Without connecting plate	With connecting plate	
1	Cover cap MS6-END	-	-	■	-	ms6-end
2	Mounting plate MS6-AEND	■ ¹⁾	-	■ ¹⁾	-	ms6-aend
3	Connecting plate-SET MS6-AG...	-	■ ¹⁾	-	■ ¹⁾	ms6-ag
	Connecting plate-SET MS6-AQ...	-	■ ¹⁾	-	■ ¹⁾	ms6-aq
4	Mounting bracket MS6-WB	■	■	-	-	ms6-wb
5	Module connector MS6-MV	-	■	■	■	ms6-mv
6	Mounting bracket MS6-WP	■	■	■	■	ms6-wp
	Mounting bracket (not shown) MS6-WPB/WPE/WPM	■	■	■	■	ms6-wp
7	Silencer U-3/4-B	■	■	■	■	60
8	MS pressure gauge AG/RG	■	■	■	■	16
9	Adapter plate for EN pressure gauge 1/4 A4	■	■	■	■	16
10	Pressure gauge MA	■	■	■	■	61
11	Pressure sensor with operational status indicator AD7 ... AD10	■	■	■	■	16
12	Connecting cable NEBU-M8...-LE3	■	■	■	■	61
13	Pressure sensor with LCD display AD1 ... AD4	■	■	■	■	16
14	Connecting cable NEBU-M8...-LE3/NEBU-M12...-LE4	■	■	■	■	61
15	Cover MS6-SV-C-MK	■	■	■	■	59
16	Illuminating seal MEB-LD	■	■	■	■	61
17	Plug socket with cable KMEB	■	■	■	■	60
18	Plug socket MSSD-EB	■	■	■	■	60
19	Connecting cable NEBU-M12G5	■	■	■	■	61
20	Connecting cable NEBU-M12W5	■	■	■	■	61

1) Module connector MS6-MV [5] or mounting bracket MS6-WP/WPB/WPE/WPM [6] is required for mounting.

 **New**

MS...-10V24C/10V24D/10V24E/10V24F

FESTO

Soft-start and quick exhaust valves MS6-SV-C, MS series

Type codes

		MS	6	-	SV	-	1/2	-	C	-	10V24	-	S
Series													
MS	Standard service unit												
Size													
6	Grid dimension 62 mm												
Service function													
SV	Soft-start and quick exhaust valve												
Pneumatic connection													
1/2	Female thread G1/2												
Performance level													
C	Category 1, to EN ISO 13849-1												
Supply voltage													
10V24	Supply voltage 24 V DC												
Silencer													
S	Silencer												

Additional variants can be ordered using the modular product system → 16

- Pneumatic connection
- Supply voltage
- Pressure gauge/pressure gauge alternatives
- Alternative pressure gauge scale
- Type of mounting
- Tamper protection
- Flow direction

Soft-start and quick exhaust valves MS6-SV-C, MS series

Technical data

MS6-SV-...-10V24/10V24F/10V24P

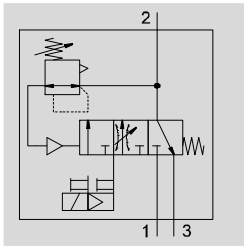

- - Flow rate
5,700 l/min
- - Temperature range
0 ... +60 °C
- - Operating pressure
3 ... 10 bar
- - www.festo.com



MS6-SV-...-10V24C/10V24D

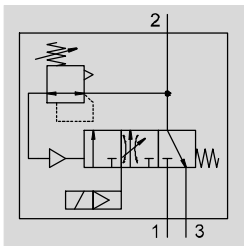

Electro-pneumatic soft-start and quick exhaust valve for gradual pressurisation and quick exhausting of system components (single channel). The main flow control valve in the cover permits a gradual build-up of output pressure p2. Once the output pressure p2 has reached the set pressure switchover point (switching pressure), the valve opens and the full operating pressure p1 is present at the output.

- Suitable for applications with high flow rates and restricted space with medium safety requirements up to controller category 1, performance level "c"
- High volumetric flow rate for pressurisation and venting
- The filling flow rate can be set via a flow control valve for gradual pressure build-up
- Adjustable pressure switchover point
- Optional pressure sensor
- Optional cover for the control sections as tamper protection

MS6-SV-...-10V24E

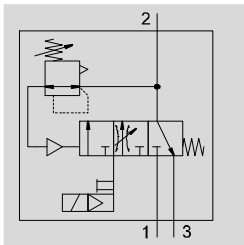

Safety characteristics	
Conforms to standard	EN ISO 13849-1
Safety function	Exhausting
	Avoidance of unexpected start-up (pressurisation)
Performance level (PL)	Exhausting: up to category 1, PL c
	Avoidance of unexpected start-up (pressurisation): up to category 1, PL c
Note on forced dynamisation	Switching frequency min. 1/month
CE marking (see declaration of conformity) ¹⁾	To EC Machinery Directive
Shock resistance	Shock test with severity level 2 according to FN 942017-5 and EN 60068-2-27
Vibration resistance	Transport application test with severity level 2 according to FN 942017-4 and EN 60068-2-6

1) Additional information www.festo.com/sp → Certificates.

Note on forced dynamisation: switching frequency min. 1/month

The mechanical system is not tested in the controlled (i.e. pressurised) state. If the process-related switching frequency (safe exhausting) is less than once a month, the machine's operator has to carry out a forced switch off.

Soft-start and quick exhaust valves MS6-SV-C, MS series

Technical data

General technical data		
Pneumatic connection 1, 2		
Female thread	G $\frac{1}{2}$	
Connecting plate AG...	G $\frac{1}{4}$, G $\frac{3}{8}$, G $\frac{1}{2}$ or G $\frac{3}{4}$	
Connecting plate AQ...	NPT $\frac{1}{4}$, NPT $\frac{3}{8}$, NPT $\frac{1}{2}$ or NPT $\frac{3}{4}$	
Pneumatic connection 3		
G $\frac{3}{4}$		
Actuation type		
Electric		
Design		
Piston spool valve		
Type of mounting		
Via accessories		
In-line installation		
Mounting position		
Any		
Pressure indicator		
Via pressure sensor for displaying output pressure via LCD display and electrical output		
Via pressure sensor for displaying output pressure via operational status indicator and electrical output		
Via pressure gauge for displaying output pressure		
Via pressure gauge with red/green scale for displaying output pressure		
G $\frac{1}{4}$ prepared		
Valve function		
3/2-way valve, closed, single solenoid		
Soft-start function, adjustable		
Non-overlapping		
Yes		
Exhaust function		
No flow control		
Manual override		
10V24/10V24F	At the pilot solenoid valve: non-detenting At the soft-start and quick exhaust valve: detenting, self-resetting	
10V24E	At the pilot solenoid valve: none At the soft-start and quick exhaust valve: detenting, self-resetting	
10V24P	At the pilot solenoid valve: non-detenting/detenting At the soft-start and quick exhaust valve: detenting, self-resetting	
10V24C/10V24D	None	
Reset method		
Mechanical spring		
Type of control		
Piloted		
Pilot air supply		
Internal		
Sealing principle		
Soft		

- || - Note: This product conforms to ISO 1179-1 and to ISO 228-1

Flow rate characteristics	
Pneumatic connection	Female thread G $\frac{1}{2}$
Standard nominal flow rate $q_{nN}^{1)}$ [l/min]	
In main flow direction 1 \rightarrow 2	5,700
Standard flow rate q_N [l/min], $p_2 = 6$ bar	
In venting direction 2 \rightarrow 3	7,600 ²⁾
C value [l/s*min]	
In main flow direction 1 \rightarrow 2	23.2
b value	
In main flow direction 1 \rightarrow 2	0.4

 1) Measured at $p_1 = 6$ bar and $p_2 = 5$ bar, $\Delta p = 1$ bar

2) Measured with respect to atmosphere with silencer S

 **New**
MS...-10V24C/10V24D/10V24E/10V24F

Soft-start and quick exhaust valves MS6-SV-C, MS series

FESTO

Technical data

Electrical data		
Coil	10V24/10V24P	24 V DC: 1.8 W; permissible voltage fluctuations –10%/+10%
characteristics	10V24C/10V24D/ 10V24E/10V24F	24 V DC: 1.8 W; permissible voltage fluctuations –15%/+10%
Electrical connection	10V24/10V24C 10V24D/10V24E/ 10V24F/10V24P	Plug, 2-pin, to EN 175301-803, type C M12x1 to ISO 20401 suitable to EN 61076-2-101
Protection class		IP65 with plug socket
Duty cycle	[%]	100
Switching time off	[ms]	65
Switching time on	[ms]	370

Operating and environmental conditions		
Operating pressure	[bar]	3 ... 10
Operating medium		Compressed air according to ISO 8573-1:2010 [7:4:4]
Note on operating/pilot medium		Lubricated operation possible (in which case lubricated operation will always be required)
Ambient temperature	[°C]	0 ... +60 (0 ... +50) ¹⁾
Temperature of medium	[°C]	0 ... +60 (0 ... +50) ¹⁾
Storage temperature	[°C]	–10 ... +60 (0 ... +50) ¹⁾
Corrosion resistance class CRC ²⁾		2
CE marking (see declaration of conformity) ³⁾		To EU Machinery Directive
Food-safe ³⁾		See supplementary material information (except solenoid valve)

1) With pressure sensor AD...

2) Corrosion resistance class CRC 2 to Festo standard FN 940070

Moderate corrosion stress. Indoor applications in which condensation may occur. External visible parts with primarily decorative requirements for the surface and which are in direct contact with the ambient atmosphere typical for industrial applications.

3) Additional information www.festo.com/sp → Certificates.

Weight [g]	
Soft-start and quick exhaust valve	886
Soft-start and quick exhaust valve with silencer S	1,006

Materials	
Housing	Die-cast aluminium
Piston rod	High-alloy stainless steel
Seals	NBR
Note on materials	RoHS-compliant

Adjusting elements

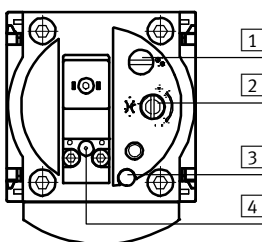

1 Screw for adjusting the pressure switchover point

2 Flow control screw for adjusting the filling time

3 Manual override at the soft-start and quick exhaust valve:

- Detenting, self-resetting as soon as the solenoid coil or manual override at the pilot solenoid valve is actuated (with 10V24/10V24E/10V24F/10V24P)
- None (with 10V24C/10V24D)

4 Manual override at the pilot solenoid valve:

- Non-detenting, actuation from above (with 10V24/10V24F)
- Non-detenting/detenting, actuation from above (with 10V24P)
- None (with 10V24C/10V24D/10V24E)

Soft-start and quick exhaust valves MS6-SV-C, MS series

Technical data

Dimensions – Basic design

Download CAD data → www.festo.com

With female thread 1/2, with cover plate

Supply voltage
10V24/10V24C

Supply voltage
10V24D/10V24E/10V24F/10V24P

1 = Unused
2 = Unused
3 = com (-)
4 = Signal (+) solenoid 14

With silencer S

1 Plug connection to EN 175301-803
2 Electrical connection M12x1 to ISO 20401 suitable to EN 61076-2-101, version 4 pin for connecting cable NEBU-M12

→ Flow direction

Type	B1	B4	B5	D1	D2	D5	L1	L2	L4
MS6-SV-C	62	31	76	G1/2	M12x1	G3/4	144	71	128

Type	L8		L9	
	10V24/10V24C	10V24D/10V24E/ 10V24F/10V24P	10V24/10V24C	10V24D/10V24E/ 10V24F/10V24P
MS6-SV-C	33	37	24	26

Note: This product conforms to ISO 1179-1 and to ISO 228-1

Dimensions – Pressure gauge/pressure gauge alternatives

Download CAD data → www.festo.com

Integrated MS pressure gauge with standard scale AG or red/green scale RG, display unit [bar]

Adapter plate A4 for EN pressure gauge 1/4, without pressure gauge

→ Flow direction

Type	B4	B5	D4
MS6-SV-...-AG	31	77	-
MS6-SV-...-RG	31	78.5	-
MS6-SV-...-A4	31	78.5	G1/4

Note: This product conforms to ISO 1179-1 and to ISO 228-1

New
MS...-10V24C/10V24D/10V24E/10V24F

Soft-start and quick exhaust valves MS6-SV-C, MS series



Technical data

Dimensions – Pressure gauge/pressure gauge alternatives

Download CAD data → www.festo.com

Pressure sensor with LCD display AD1 ... AD4

Technical data → Internet: sde1

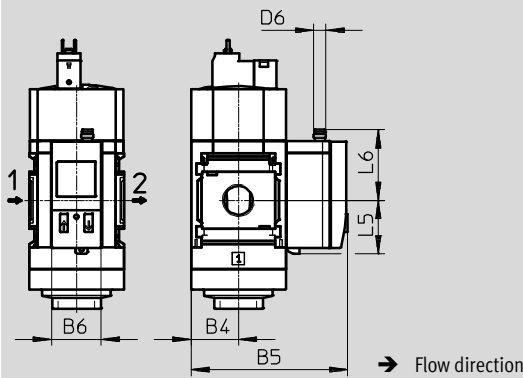

Variant AD1:
 SDE1-D10-G2-MS-L-P1-M8 with
 3-pin plug M8x1, 1 switching out-
 put PNP

Variant AD3:
 SDE1-D10-G2-MS-L-PI-M12 with
 4-pin plug M12x1, 1 switching out-
 put PNP and 4 ... 20 mA analogue

Variant AD2:
 SDE1-D10-G2-MS-L-N1-M8 with
 3-pin plug M8x1, 1 switching out-
 put NPN

Variant AD4:
 SDE1-D10-G2-MS-L-NI-M12 with
 4-pin plug M12x1, 1 switching out-
 put NPN and 4 ... 20 mA analogue

Pressure sensor with operational status indicator AD7 ... AD10

Technical data → Internet: sde5

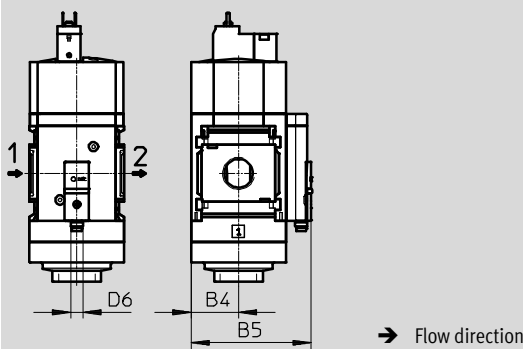

Variant AD7:
 SDE5-D10-O-...-P-M8 with 3-pin
 plug M8x1, threshold value compar-
 ator, 1 switching output PNP, N/O
 contact

Variant AD9:
 SDE5-D10-O3-...-P-M8 with 3-pin
 plug M8x1, window comparator, 1
 switching output PNP, N/O contact

Variant AD8:
 SDE5-D10-C-...-P-M8 with 3-pin
 plug M8x1, threshold value compar-
 ator, 1 switching output PNP, N/C
 contact

Variant AD10:
 SDE5-D10-C3-...-P-M8 with 3-pin
 plug M8x1, window comparator, 1
 switching output PNP, N/C contact

Type	B4	B5	B6	D6	L5	L6
MS6-SV-...-AD1/AD2	31	102	32.3	M8x1	35.1	46.7
MS6-SV-...-AD3/AD4				M12x1		55.8
MS6-SV-...-AD7/AD8/AD9/AD10	31	79	-	M8x1	-	-

★ **Core product range**

Ordering data		
Size	Connection	With silencer
		Part No. Type
Cover plate		
MS6	G½	★ 8001469 MS6-SV-½-C-10V24-S

Festo core product range

- ★ Generally ready for shipping ex works in 24 hours
- ☆ Generally ready for shipping ex works in 5 days

 **New**

MS...-10V24C/10V24D/10V24E/10V24F

Soft-start and quick exhaust valves MS6-SV-C, MS series



Ordering data – Modular products

M Mandatory data						
Module No.	Series	Size	Function	Pneumatic connection	Performance level	Supply voltage
548713	MS	6	SV	1/2, AG..., AQ...	C	10V24, 10V24C, 10V24D, 10V24E, 10V24F, 10V24P
Ordering example						
548713	MS	6	- SV	- AGB	- C	- 10V24

Ordering table					
Grid dimension	[mm]	62	Conditions	Code	Enter code
M	Module No.	548713			
	Series	Standard		MS	MS
	Size	6		6	6
	Function	Soft-start and quick exhaust valve		-SV	-SV
	Pneumatic connection	Female thread G1/2		-1/2	
		Connecting plate G1/4		-AGB	
		Connecting plate G3/8		-AGC	
		Connecting plate G1/2		-AGD	
		Connecting plate G3/4		-AGE	
		Connecting plate NPT1/4		-AQN	
		Connecting plate NPT3/8		-AQP	
		Connecting plate NPT1/2		-AQR	
		Connecting plate NPT3/4		-AQS	
		Performance level	Category 1, 1-channel, to EN ISO 13849-1		-C
	Supply voltage	24 V DC (pin allocation to EN 175301), 3 ... 10 bar, manual override – at the soft-start and quick exhaust valve: detenting, self-resetting – at the pilot solenoid valve: non-detenting		-10V24	
		24 V DC (pin allocation to EN 175301), 3 ... 10 bar, none manual override		-10V24C	
		24 V DC, M12x1 to ISO 20401 suitable to EN 61076-2-101, 3 ... 10 bar, none manual override		-10V24D	
		24 V DC, M12x1 to ISO 20401 suitable to EN 61076-2-101, 3 ... 10 bar, manual override – at the soft-start and quick exhaust valve: detenting, self-resetting – at the pilot solenoid valve: none		-10V24E	
		24 V DC, M12x1 to ISO 20401 suitable to EN 61076-2-101, 3 ... 10 bar, manual override – at the soft-start and quick exhaust valve: detenting, self-resetting – at the pilot solenoid valve: non-detenting		-10V24F	
		24 V DC, M12x1 to ISO 20401 suitable to EN 61076-2-101, 3 ... 10 bar, manual override – at the soft-start and quick exhaust valve: detenting, self-resetting – at the pilot solenoid valve: non-detenting/detenting		-10V24P	

Transfer order code

548713	MS	6	- SV	-	AGB	-	C	-	10V24
--------	----	---	------	---	-----	---	---	---	-------

Soft-start and quick exhaust valves MS6-SV-C, MS series

Ordering data – Modular products

Options					
Silencer	Pressure gauge/ pressure gauge alternatives	Alternative pressure gauge scale	Type of mounting	Tamper protection	Flow direction
S	AG, A4, RG, AD1 ... AD4, AD7 ... AD10	PSI, MPA	WP, WPM, WPB, WB	MK	Z
- S	- AG	-	- WP	-	-

Ordering table					
Grid dimension	[mm]	62	Condi- tions	Code	Enter code
0 Silencer		Silencer		-S	
Pressure gauge/pressure gauge alternatives		MS pressure gauge	1	-AG	
		Adapter plate for EN pressure gauge 1/4, without pressure gauge		-A4	
		Integrated pressure gauge, red/green scale	1	-RG	
		Pressure sensor with LCD display, plug M8, 1 switching output PNP, 3-pin	2	-AD1	
		Pressure sensor with LCD display, plug M8, 1 switching output NPN, 3-pin	2	-AD2	
		Pressure sensor with LCD display, plug M12, 1 switching output PNP, 4-pin, analogue output 4 ... 20 mA	2	-AD3	
		Pressure sensor with LCD display, plug M12, 1 switching output NPN, 4-pin, ana- logue output 4 ... 20 mA	2	-AD4	
		Pressure sensor with operational status indicator, plug M8, threshold value comparator, PNP, N/O contact	2	-AD7	
		Pressure sensor with operational status indicator, plug M8, threshold value comparator, PNP, N/C contact	2	-AD8	
		Pressure sensor with operational status indicator, plug M8, window comparator, PNP, N/O contact	2	-AD9	
		Pressure sensor with operational status indicator, plug M8, window comparator, PNP, N/C contact	2	-AD10	
	Alternative pressure gauge scale		psi	3	-PSI
		MPa	4	-MPA	
Type of mounting		Mounting bracket standard design		-WP	
		Mounting bracket for attaching the service units	5	-WPM	
		Mounting bracket for large wall gap		-WPB	
		Mounting bracket centrally at rear (wall mounting top and bottom), connecting plates not required		-WB	
Tamper protection		Complete (manual override at soft-start/quick exhaust valve locked, adjusting screw locked, manual override at pilot solenoid valve locked)		-MK	
Flow direction		Flow direction from right to left		-Z	

1 **AG, RG** Pressure gauge scale in bar
 2 **AD1 ... AD4, AD7 ... AD10**
 Measuring range max. 10 bar

3 **PSI** Only in combination with pressure gauge AG.
 4 **MPA** Only in combination with pressure gauge AG or RG.
 5 **WPM** Only with connecting plate AGB, AGC, AGD, AGE, AQN, AQP, AQR or AQS

Transfer order code

- - - - - -

Soft-start and quick exhaust valves MS6-SV-D, MS series

Peripherals overview

Soft-start and quick exhaust valve MS6-SV-D

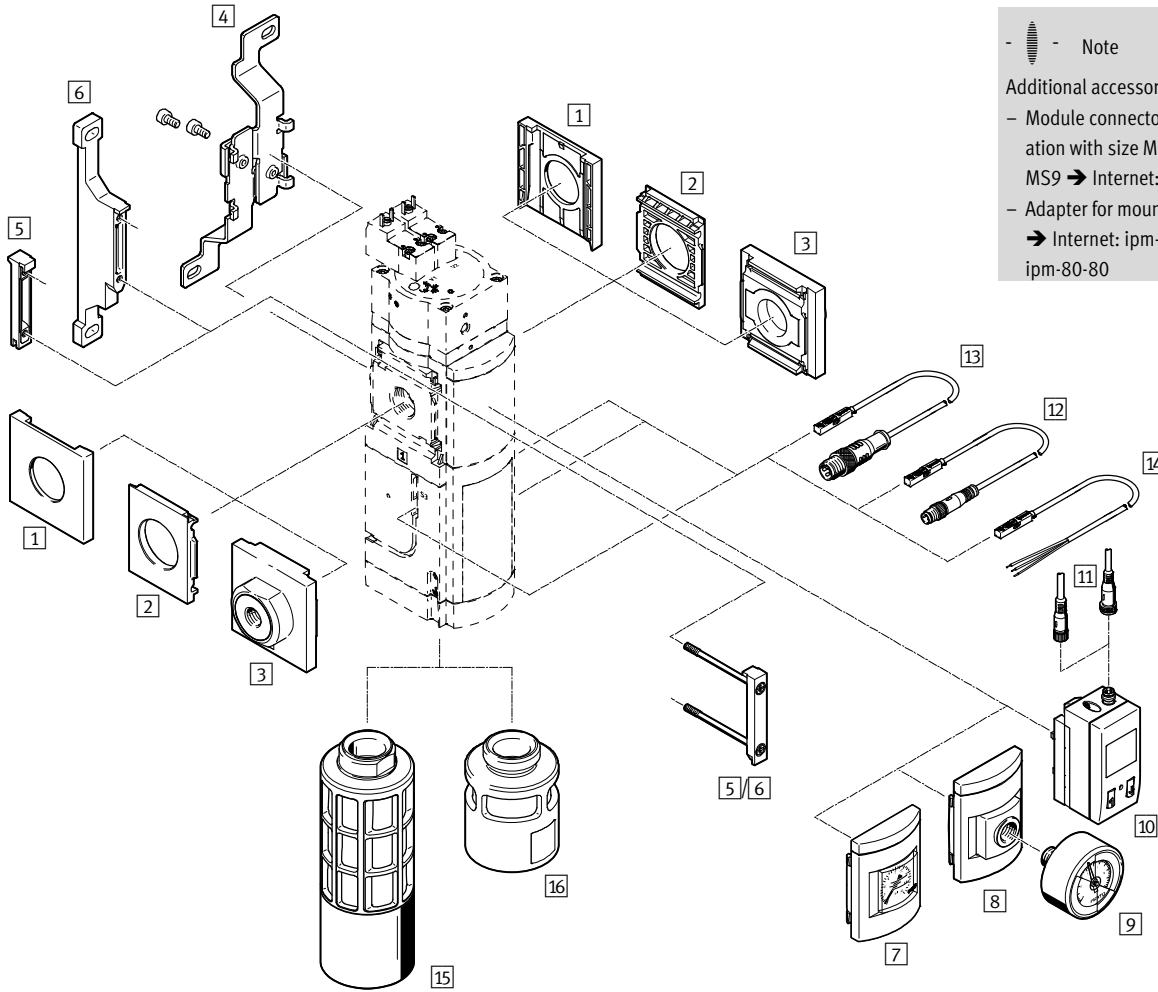

-  - Note

Additional accessories:

- Module connector for combination with size MS4/MS6 or size MS9 → Internet: amv, rmv, armv
- Adapter for mounting on profiles → Internet: ipm-80, ipm-40-80, ipm-80-80

Supply voltage
10V24

Supply voltage
10V24P

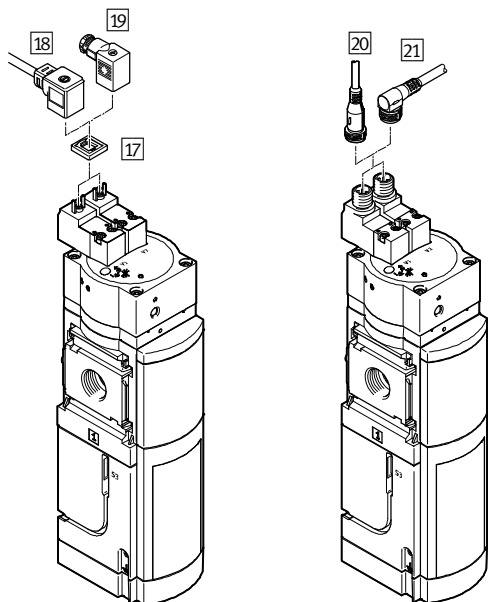

Soft-start and quick exhaust valves MS6-SV-D, MS series

Peripherals overview

Mounting components and accessories						
		Individual device		Combination		→ Page/Internet
		Without connecting plate	With connecting plate	Without connecting plate	With connecting plate	
1	Cover cap MS6-END	-	-	■	-	ms6-end
2	Mounting plate MS6-AEND	■ ¹⁾	-	■ ¹⁾	-	ms6-aend
3	Connecting plate kit MS6-AG...	-	■ ¹⁾	-	■ ¹⁾	ms6-ag
	Connecting plate kit MS6-AQ...	-	■ ¹⁾	-	■ ¹⁾	ms6-aq
4	Mounting bracket MS6-WB	■	■	-	-	ms6-wb
5	Module connector MS6-MV	-	■	■	■	ms6-mv
6	Mounting bracket MS6-WP	■	■	■	■	ms6-wp
	Mounting bracket (not shown) MS6-WPB/WPE/WPM	■	■	■	■	ms6-wp
7	MS pressure gauge AG/RG	■	■	■	■	30
8	Adapter for EN pressure gauge 1/4 A4	■	■	■	■	30
9	Pressure gauge MA	■	■	■	■	61
10	Pressure sensor with LCD display AD1 ... AD4	■	■	■	■	30
11	Connecting cable NEBU-M8...-LE3/NEBU-M12...-LE4	■	■	■	■	61
12	Proximity sensor 2M8/S3, SMT-8M-A...-M8D	■	■	■	■	30, 60
13	Proximity sensor 2M12/S3, SMT-8M-A...-M12	■	■	■	■	30, 60
14	Proximity sensor 2OE/S3, SMT-8M-A...-OE	■	■	■	■	30, 60
15	Pneumatic Silencer SO, UOS-1	■	■	■	■	30, 58
16	Pneumatic Silencer UOS-1-LF	■	■	■	■	58
17	Illuminating seal MEB-LD	■	■	■	■	61
18	Plug socket with cable KMEB	■	■	■	■	60
19	Plug socket MSSD-EB	■	■	■	■	60
20	Connecting cable NEBU-M12G5	■	■	■	■	61
21	Connecting cable NEBU-M12W5	■	■	■	■	61

1) Module connector MS6-MV [5] or mounting bracket MS6-WP/WPB/WPE/WPM [6] is required for mounting.

Soft-start and quick exhaust valves MS6-SV-D, MS series

Type codes

MS 6 - SV - 1/2 - D - 10V24 - 20E - SO - AG

Series	
MS	Standard service unit
Size	
6	Grid dimension 62 mm
Service function	
SV	Soft-start and quick exhaust valve
Pneumatic connection	
1/2	Female thread G1/2
Performance Level	
D	Category 3, 2-channel, to EN ISO 13849-1
Supply voltage	
10V24	24 V DC (connection to EN 175301)
10V24P	24 V DC, M12 to IEC 61076-2-101
Connection technology	
2M8	2 proximity sensors SMT (cable with plug connector M8x1, 3-pin, cable length 0.3 m)
2M12	2 proximity sensors SMT (cable with plug connector M12x1, 3-pin, cable length 0.3 m)
20E	2 proximity sensors SMT (cable with open end, cable length 5 m)
Pneumatic silencer	
	Without pneumatic silencer
SO	Pneumatic silencer open
Pressure gauge/pressure gauge alternatives	
	Cover plate
AG	MS pressure gauge

Additional variants can be ordered using the modular product system → 30

- Pneumatic connection
- Extended sensing
- Pressure gauge/pressure gauge alternatives
- Alternative pressure gauge scale
- Type of mounting
- UL certification
- Flow direction

Soft-start and quick exhaust valves MS6-SV-D, MS series

Technical data

Function

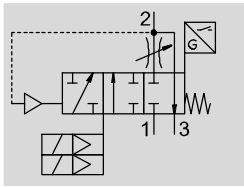

- - Flow rate
4300 l/min
- - Temperature range
-10 ... +50 °C
- - Operating pressure
3.5 ... 10 bar
- - www.festo.com



The electropneumatic soft-start and quick exhaust valve is used to reduce pressure quickly and safely and to build up pressure gradually in industrial pneumatic piping systems and terminal equipment.

The MS6-SV-D has two safety functions:

- pressure release
- protection from unexpected start-up (non-switching)

The MS6-SV-D has a 2-channel structure, i.e. it has two internal 2-way

valves which can be controlled separately by pilot valves (V1 and V2) situated on the cover. These valves are actuated when both coils are energised simultaneously; this changes the MS6-SV-D from the normal position to the switching position. The outlet pressure p2 rises slowly in accordance with the throttle setting. The main seat opens when the switch-through pressure is reached. The normal position is achieved by switching off both coils.

Two proximity sensors (S1 and S2) secured on the housing monitor the directional control valves. A further proximity sensor (S3) can optionally be added to monitor the soft-start valve.

The MS6-SV-D can achieve various categories and safety levels to EN ISO 13849-1 depending on how the directional control valves are monitored.

Where there is appropriate integration into the control chain as well as

appropriate linking of the signals for initial position sensing with the signals for activation (plausibility checking):

- Performance Level d/category 3 to EN ISO 13849-1 and EN ISO 13849-2 can be achieved when using sensors S1 and S2 and
- Performance Level e/category 4 to EN ISO 13849-1 and EN ISO 13849-2 can be achieved when using sensors S1, S2 and S3.

- Note
To avoid back pressures, it is recommended that the device be operated together with the silencer UOS-1. The silencer can be ordered via the modular product system (SO → 30) or as an accessory (UOS-1 → 58).

- Note
Only devices that do not impair pressure release may be positioned downstream of the MS6-SV-...-D. The MS6-SV-...-D is not permitted for use as a press safety valve.

- Conforms to standard IEC 61508
- Switching time delay adjustable via a flow control valve for gradual pressure build-up; main seat opens at approx. 50% of operating pressure
- Optional pressure sensor

Soft-start and quick exhaust valves MS6-SV-D, MS series

Technical data

Safety characteristics		
Conforms to standard	EN ISO 13849-1 and EN ISO 13849-2	
Safety function	Exhausting	
	Avoidance of unexpected start-up (pressurisation)	
Performance Level (PL)	With sensing by S1 and S2	Exhausting: category 3, PL d or category 3, PL e ¹⁾
		Avoidance of unexpected start-up (pressurisation): category 3, PL d or category 3, PL e ¹⁾
	With sensing by S1, S2 and S3	Exhausting: category 4, PL e
		Avoidance of unexpected start-up (pressurisation): category 4, PL e
Safety integrity level (SIL)	Exhausting: SIL 3	
	Avoidance of unexpected start-up (pressurisation): SIL 3	
Note on forced dynamisation	Switching frequency min. 1/month	
CE marking (see declaration of conformity) ²⁾	To EC Machinery Directive	
Shock resistance	Shock test with severity level 2 according to FN 942017-5 and EN 60068-2-27	
Vibration resistance	Transport application test with severity level 2 according to FN 942017-4 and EN 60068-2-6	

1) Dependent on the average number of annual actuations (n_{op}).

2) Additional information www.festo.com/sp → Certificates.

 **Note on forced dynamisation: switching frequency min. 1/month**

The mechanical system is not tested in the controlled (i.e. pressurised) state. If the process-related switching frequency (safe exhausting) is less than once a month, the machine's operator has to carry out a forced switch off.

Soft-start and quick exhaust valves MS6-SV-D, MS series

Technical data

Switching logic	Voltage at the pilot valve		Switching position Proximity sensor			Status
	V1	V2	S1	S2	S3	
In the normal position (completely exhausted MS6-SV-D), the pilot valves V1 and V2 are not actuated. If both pilot valves are actuated, the MS6-SV-D switches first into switching position 1 and then, when the switch-through pressure is reached, automatically into switching position 2.	0 V	0 V	1	1	1	Normal position Pneumatic port 1 closed, passage from pneumatic port 2 to 3 open
	24 V	0 V	0	1	1	Normal position Pneumatic port 1 closed, passage from pneumatic port 2 to 3 open
	0 V	24 V	1	0	1	Normal position Reduced flow through flow control valve from pneumatic port 1 to 2, passage from pneumatic port 2 to 3 open
	24 V	24 V	0	0	1	Switching element position 1 Reduced flow through flow control valve from pneumatic port 1 to 2, passage from pneumatic port 2 to 3 closed
	24 V	24 V	0	0	0	Switching position 2 Full flow from pneumatic port 1 to 2, passage from pneumatic port 2 to 3 closed

Proximity sensor response times ¹⁾		
Proximity sensor	Switching on	Switching off
S1	Edge change max. 4 s after voltage signal at V1.	Edge change max. 4 s after voltage drop at V1.
S2	Edge change max. 4 s after voltage signal at V2.	Edge change max. 4 s after voltage drop at V2.
S3	Edge change after voltage signal at V1 and V2. Dependent on operating pressure p1, throttle position and system volume p2	Edge change max. 5 s after voltage drop at V1 and V2. Dependent on system volume at p2.

1) When the proximity sensors undergo an edge change, bounce can occur. This bounce can be ignored by taking the response times into account. The maximum specified response times must be considered in the diagnostics. The response times are normally shorter.

Example circuit

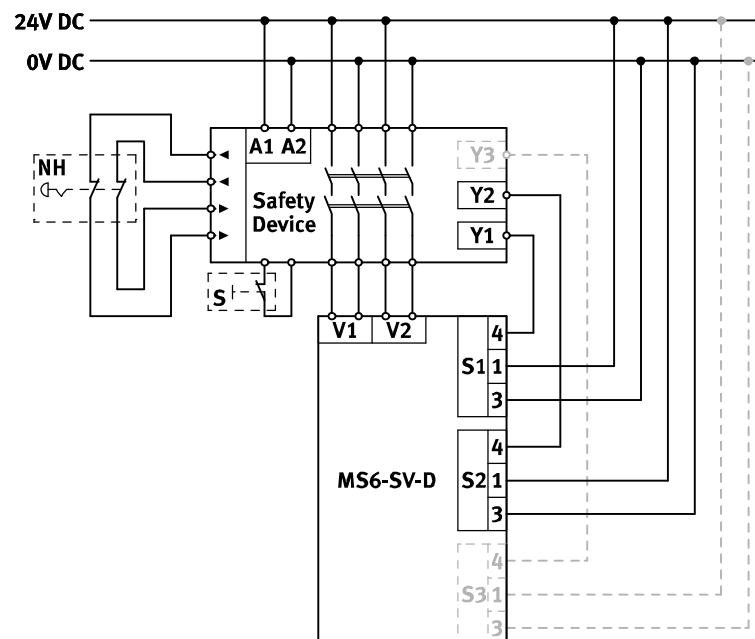

- A1, A2: Supply voltage
- S1: Proximity sensor S1
- S2: Proximity sensor S2
- S3: Proximity sensor S3
- NH: Emergency stop (input circuit)
- Safety device: Safety switching device or safety PLC
- V1: Coil connection, pilot valve V1
- V2: Coil connection, pilot valve V2
- Y1: Diagnostic input 1
- Y2: Diagnostic input 2
- Y3: Diagnostic input 3
- S: Monitored start (start circuit)

Soft-start and quick exhaust valves MS6-SV-D, MS series

FESTO

Technical data

General technical data	
Pneumatic port 1, 2	
Female thread	G1/2
Connecting plate AG...	G1/4, G3/8, G1/2 or G3/4
Connecting plate AQ...	NPT1/4, NPT3/8, NPT1/2 or NPT3/4
Pneumatic port 3	G1
Actuation type	Electric
Design	Piston seat
Type of mounting	Via accessories
	In-line installation
Mounting position	Any
Pressure indicator	Via pressure sensor for displaying output pressure via LCD display and electrical output
	Via pressure gauge for displaying output pressure
	Via pressure gauge with red/green scale for displaying output pressure
	G1/4 prepared
Position sensing principle	Magnetic piston principle
Valve function	3/2-way valve, closed, single solenoid
	Soft-start function, adjustable
Non-overlapping	No
Exhaust function	No flow control
Manual override	None
Reset method	Mechanical spring
Type of control	Piloted
Pilot air supply	Internal
Sealing principle	Soft

• Note: This product conforms to ISO 1179-1 and to ISO 228-1

Flow rate characteristics	
Pneumatic connection	Female thread G1/2
Standard nominal flow rate $q_{nN}^{1)}$ [l/min]	
In main flow direction 1 \rightarrow 2	4300
Standard flow rate q_N [l/min], $p_2 = 6$ bar	
In venting direction 2 \rightarrow 3	9000 ²⁾
C value [l/s*min]	
In main flow direction 1 \rightarrow 2	19.3
b value	
In main flow direction 1 \rightarrow 2	0.21

1) Measured at $p_1 = 6$ bar and $p_2 = 5$ bar, $\Delta p = 1$ bar

2) Measured with respect to atmosphere with silencer UOS-1

Soft-start and quick exhaust valves MS6-SV-D, MS series

Technical data

Electrical data		
Pilot valve		
Coil characteristics		24 V DC: 1.8 W; permissible voltage fluctuations -15%/+10%
Electrical connection	10V24	2 x plug connectors, 2-pin, to EN 175301-803, type C
	10V24P	2 x M12x1 to ISO 20401 suitable to EN 61076-2-101
Degree of protection		IP65 with plug socket
Duty cycle	[%]	100
Max. switching frequency	[Hz]	1
Switching time off	[ms]	40
Switching time on	[ms]	130
Proximity sensor		
Nominal operating voltage	[V DC]	24
Electrical connection, proximity sensor	2M8	2 x cables with plug connector M8x1, 3-pin, rotatable thread, cable length 0.3 m
	2M12	2 x cables with plug connector M12x1, 3-pin, rotatable thread, cable length 0.3 m
	2OE	2 x cable with open end, 3-wire, cable length 5 m
	2M8 + S3	3 x cables with plug connector M8x1, 3-pin, rotatable thread, cable length 0.3 m
	2M12 + S3	3 x cables with plug connector M12x1, 3-pin, rotatable thread, cable length 0.3 m
	2OE + S3	3 x cable with open end, 3-wire, cable length 5 m
Switching element function		N/O contact
Measuring principle		Magneto-resistive
Signal status display		LED and switching outputs
Switching output		PNP

Operating and environmental conditions		
Operating pressure	[bar]	3.5 ... 10
Operating medium		Compressed air according to ISO 8573-1:2010 [7:4:4]
Note on operating/pilot medium		Lubricated operation possible (in which case lubricated operation will always be required)
Ambient temperature	[°C]	-10 ... +50 (0 ... +50) ¹⁾
Temperature of medium	[°C]	-10 ... +50 (0 ... +50) ¹⁾
Storage temperature	[°C]	-10 ... +50 (0 ... +50) ¹⁾
Corrosion resistance class CRC ²⁾		2
Noise level	[dB(A)]	75 (with silencer UOS-1)
CE marking (see declaration of conformity) ³⁾		To EU Machinery Directive
UL certification ³⁾		c UL us - Recognized (OL)
Certification		RCM Mark
KC marking		KC EMC

1) With pressure sensor AD...

2) Corrosion resistance class CRC 2 to Festo standard FN 940070

Moderate corrosion stress. Indoor applications in which condensation may occur. External visible parts with primarily decorative requirements for the surface and which are in direct contact with the ambient atmosphere typical for industrial applications.

3) Additional information www.festo.com/sp → Certificates.

Soft-start and quick exhaust valves MS6-SV-D, MS series

Technical data

Weight [g]	
Soft-start/quick exhaust valve	1900
Soft-start/quick exhaust valve with silencer UOS-1	2110

Materials	
Housing	Die-cast aluminium
Piston rod	High-alloy stainless steel
Seals	NBR
Note on materials	RoHS-compliant

Switch-through pressure

Pressure p as a function of time t

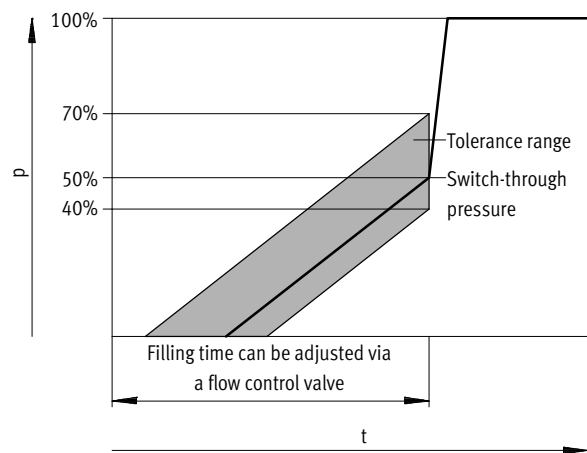

Note

The +20%/–10% switch-through pressure tolerance refers to the operating pressure p_1 .
 Example: A switch-through pressure from 1.6 bar to 2.8 bar is permissible at an operating pressure of 4 bar.

Soft-start and quick exhaust valves MS6-SV-D, MS series

Technical data

Dimensions – Basic design

Download CAD data → www.festo.com

With supply voltage 10V24, with female thread 1/2, with cover plate

With supply voltage 10V24P, with female thread 1/2, with cover plate

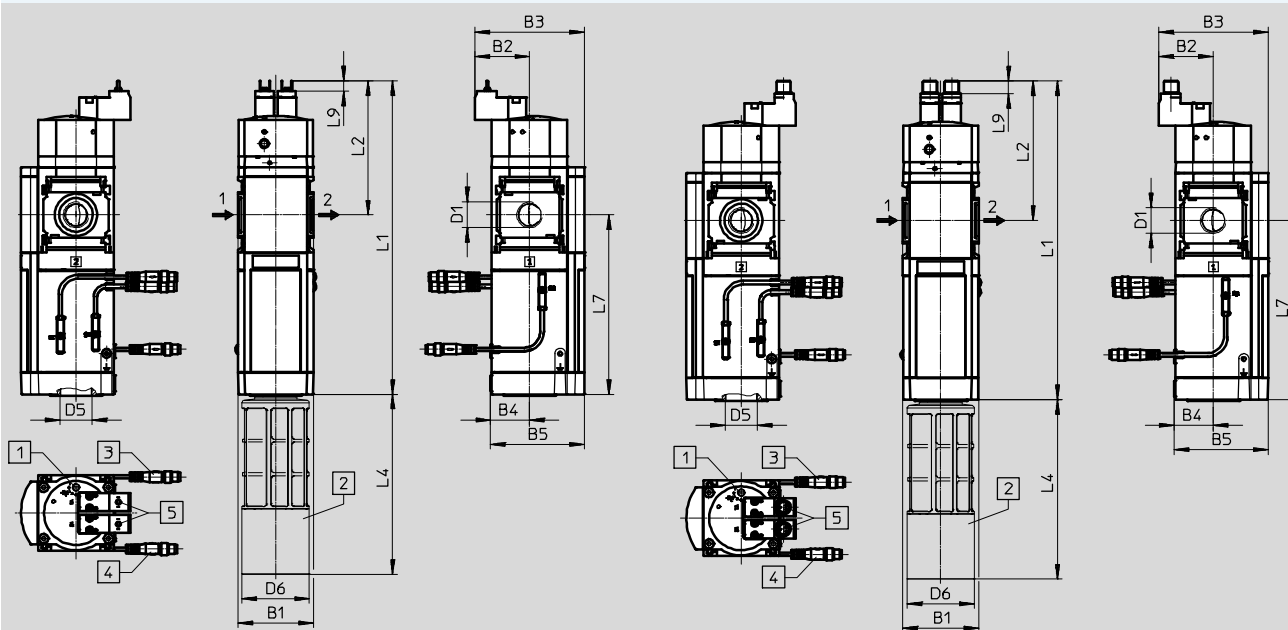

- 1 = Unused
- 2 = Unused
- 3 = com (-)
- 4 = Signal (+) solenoid 14

- 1 Regulating screw for flow control valve
 - 2 Silencer UOS-1
 - 3 Extended sensing, variant S3: additional third proximity sensor SMT, port depends on connection technology chosen 4
 - 4 Connection technology,
 - variant 2M8: 2 proximity sensors SMT with cable (plug connector M8x1, 3-pin, rotatable thread, cable length 0.3 m)
 - variant 2M12: 2 proximity sensors SMT with cable (plug connector M12x1, 3-pin, rotatable thread, cable length 0.3 m)
 - variant 20E: 2 proximity sensors SMT with cable (open end, 3-wire, cable length 5 m)
 - 5 Supply voltage,
 - variant 10V24: Electrical connection to EN 175301-803, 2 x plug connectors, 2-pin, type C
 - variant 10V24P: Electrical connection 2 x M12x1 to ISO 20401 suitable to EN 61076-2-101, version 4 pin for connecting cable NEBU-M12
- Flow direction

Type	B1	B2	B3	B4	B5	D1	D5	D6 ∅	L1	L2	L4	L7	L9
MS6-SV-1/2-D-10V24	62	45	90	31	76	G1/2	G1	55	257	110	147	147	9
MS6-SV-1/2-D-10V24P									262	115			11

- | - Note: This product conforms to ISO 1179-1 and to ISO 228-1

Soft-start and quick exhaust valves MS6-SV-D, MS series

Technical data

Dimensions – Pressure gauge/pressure gauge alternatives Download CAD data → www.festo.com

Integrated MS pressure gauge with standard scale AG or red/green scale RG, display unit [bar] Adapter A4 for EN pressure gauge 1/4, without pressure gauge

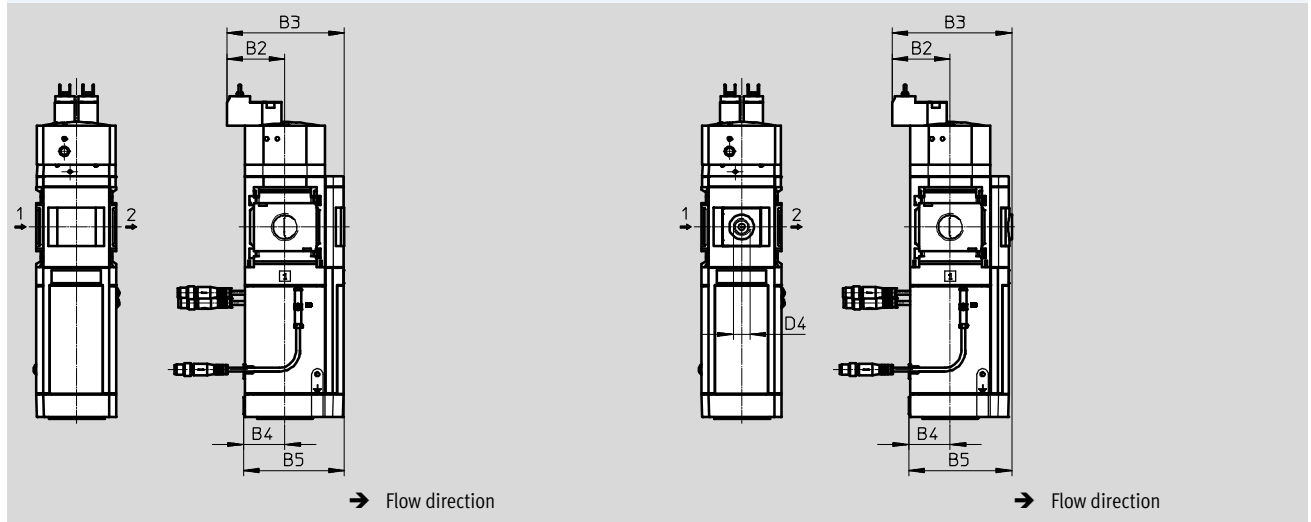

Type	B2	B3	B4	B5	D4
MS6-SV-...-D-...-AG	44	90	31	77	-
MS6-SV-...-D-...-RG	44	91.5	31	78.5	-
MS6-SV-...-D-...-A4	44	91.5	31	78.5	G1/4

Note: This product conforms to ISO 1179-1 and to ISO 228-1

Dimensions – Pressure gauge/pressure gauge alternatives Download CAD data → www.festo.com

Pressure sensor with LCD display AD1 ... AD4 Technical data → Internet: [sde1](http://sde1.festo.com)

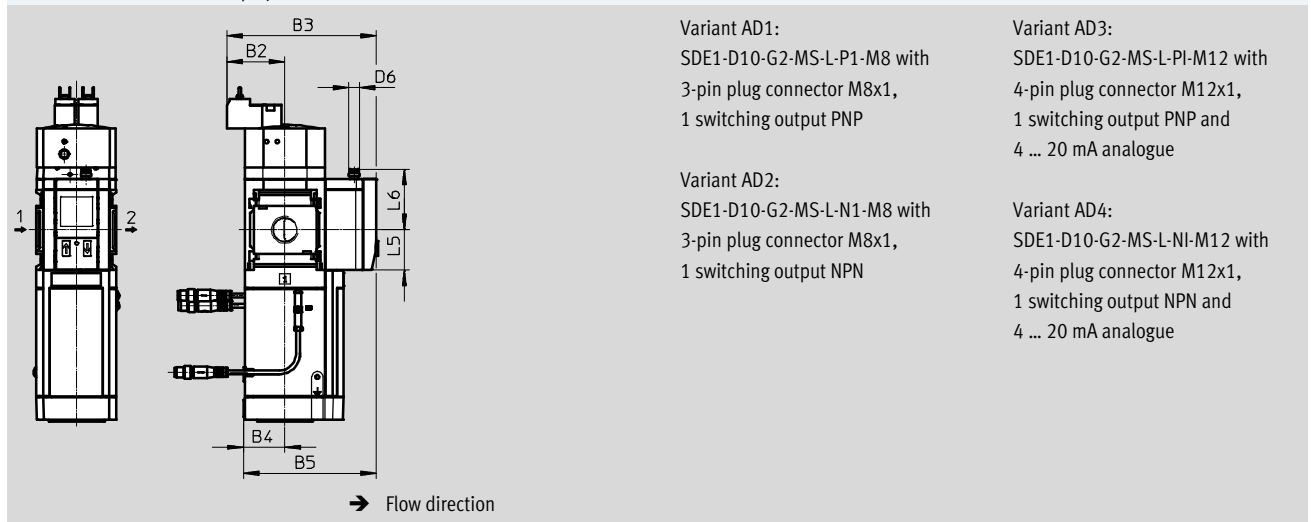

Type	B2	B3	B4	B5	D6	L5	L6
MS6-SV-...-D-...-AD1/AD2	44	116	31	103	M8x1	31.2	46.8
MS6-SV-...-D-...-AD3/AD4					M12x1		55.8

Note: This product conforms to ISO 1179-1 and to ISO 228-1

Soft-start and quick exhaust valves MS6-SV-D, MS series

FESTO

Technical data

Ordering data					
Size	Port	Without pneumatic silencer, with cover plate		With silencer and MS pressure gauge with standard scale, display unit [bar]	
		Part No.	Type	Part No.	Type
Electrical connection to EN 175301-803 (2 x plug connectors, 2-pin, type C), 2 proximity sensors SMT with cable (plug connector M8x1, 3-pin, rotatable thread, cable length 0.3 m)					
MS6	G1/2	8038489	MS6-SV-1/2-D-10V24-2M8	8038490	MS6-SV-1/2-D-10V24-2M8-SO-AG
Electrical connection to IEC 61076-2-101 (2 x plug connectors M12x1, 2-pin for NEBU-M12), 2 proximity sensors SMT with cable (plug connector M12x1, 3-pin, rotatable thread, cable length 0.3 m)					
MS6	G1/2	–		8038491	MS6-SV-1/2-D-10V24P-2M12-SO-AG
Electrical connection to EN 175301-803 (2 x plug connectors, 2-pin, type C), 2 proximity sensors SMT with cable (open end, 3-wire, cable length 5 m)					
MS6	G1/2	–		8038492	MS6-SV-1/2-D-10V24-20E-SO-AG

Soft-start and quick exhaust valves MS6-SV-D, MS series

Ordering data – Modular products

M Mandatory data →							
Module no.	Series	Size	Function	Pneumatic connection	Performance Level	Supply voltage	Connection technology
548713	MS	6	SV	1/2, AG..., AQ...	D	10V24, 10V24P	2M8, 2M12, 20E
Ordering example							
548713	MS	6	- SV	- AGB	- D	- 10V24	- 20E

Ordering table					
Grid dimension	[mm]		Conditions	Code	Entry code
M	Module no.	548713			
	Series	Standard		MS	MS
	Size	6		6	6
	Function	Soft-start and quick exhaust valve		-SV	-SV
	Pneumatic connection	Female thread G1/2		-1/2	
		Connecting plate G1/4		-AGB	
		Connecting plate G3/8		-AGC	
		Connecting plate G1/2		-AGD	
		Connecting plate G3/4		-AGE	
		Connecting plate NPT1/4		-AQN	
		Connecting plate NPT3/8		-AQP	
		Connecting plate NPT1/2		-AQR	
		Connecting plate NPT3/4		-AQS	
	Performance Level	Category 3, 2-channel, to EN ISO 13849-1		-D	-D
	Supply voltage	24 V DC (pin allocation to EN 175301)		-10V24	
		24 V DC, M12x1 to ISO 20401 suitable to EN 61076-2-101		-10V24P	
	Connection technology	2 proximity sensors SMT with cable plug connector M8x1, 3-pin, rotatable thread, cable length 0.3 m)		-2M8	
		2 proximity sensors SMT with cable (plug connector M12x1, 3-pin, rotatable thread, cable length 0.3 m)		-2M12	
		2 proximity sensors SMT with cable (open end, 3-wire, cable length 5 m)		-20E	

Transfer order code

548713	MS	6	- SV	-	D	-	-
---------------	-----------	----------	-------------	----------	----------	----------	----------

Soft-start and quick exhaust valves MS6-SV-D, MS series

Ordering data – Modular products

Options						
Extended sensing	Silencer	Pressure gauge/pressure gauge alternatives	Alternative pressure gauge scale	Type of mounting	UL certification	Flow direction
S3	S0	AG, A4, RG, AD1 ... AD4	PSI, MPA	WP, WPM, WPB, WB	UL1	Z
- S3	- S0	- AG		- WPB		

Ordering table					
Grid dimension	[mm]		Conditions	Code	Entry code
0	Extended sensing	Additional proximity sensor SMT; required to achieve Performance Level e; port depends on connection technology chosen		-S3	
	Silencer	Silencer open		-S0	
	Pressure gauge/pressure gauge alternatives	MS pressure gauge	1	-AG	
		Adapter for EN pressure gauge 1/4, without pressure gauge		-A4	
		Integrated pressure gauge, red/green scale	1	-RG	
		Pressure sensor with LCD display, plug connector M8, 1 switching output PNP, 3-pin		-AD1	
		Pressure sensor with LCD display, plug connector M8, 1 switching output NPN, 3-pin		-AD2	
		Pressure sensor with LCD display, plug connector M12, 1 switching output PNP, 4-pin, analogue output 4 ... 20 mA		-AD3	
		Pressure sensor with LCD display, plug connector M12, 1 switching output NPN, 4-pin, analogue output 4 ... 20 mA		-AD4	
	Alternative pressure gauge scale	psi	2	-PSI	
		MPa	3	-MPA	
	Type of mounting	Mounting bracket standard design		-WP	
		Mounting bracket for attaching the service units	4	-WPM	
		Mounting bracket for large wall gap		-WPB	
		Mounting bracket centrally at rear (wall mounting top and bottom), connecting plates not required		-WB	
	UL certification	cULus, ordinary location for Canada and USA		-UL1	
	Flow direction	Flow direction from right to left		-Z	

- 1 AG, RG Pressure gauge scale in bar
- 2 PSI Only in combination with pressure gauge AG.
- 3 MPA Only in combination with pressure gauge AG or RG.
- 4 WPM Only with connecting plates AGB, AGC, AGD, AGE, AQN, AQP, AQR or AQS

Transfer order code

- [] - [] - [] - [] - [] - [] - []

Soft-start and quick exhaust valves MS6-SV-E, MS series

Peripherals overview

Soft-start and quick exhaust valve MS6-SV-E

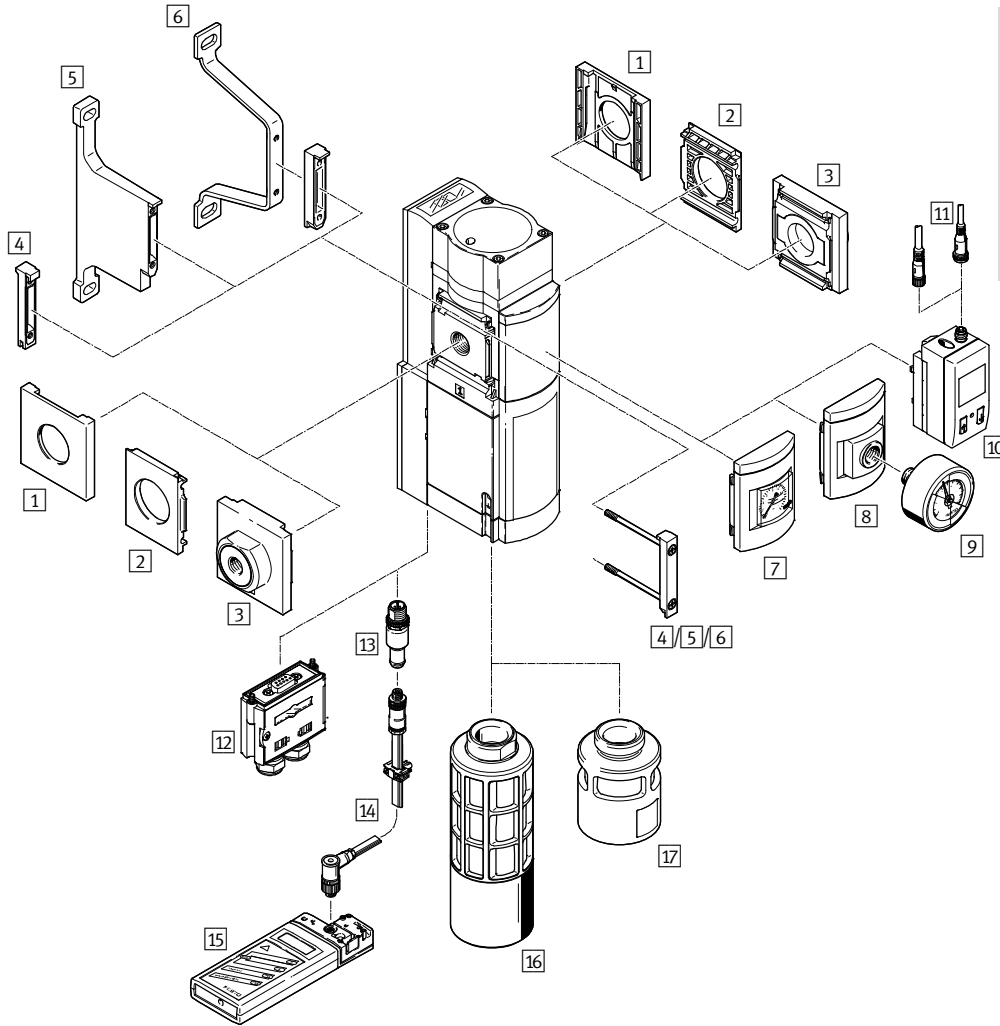

-  - Note

Additional accessories:

- Module connector for combination with size MS4/MS6 or size MS9 → Internet: amv, rmv, armv
- Adapter plate for mounting on profiles → Internet: ipm-80, ipm-40-80, ipm-80-80

Soft-start and quick exhaust valves MS6-SV-E, MS series

Peripherals overview

Mounting attachments and accessories						
		Individual device		Combination		→ Page/Internet
		Without connect- ing plate	With connecting plate	Without connect- ing plate	With connecting plate	
1	Cover cap MS6-END	-	-	■	-	ms6-end
2	Mounting plate MS6-AEND	■ ¹⁾	-	■ ¹⁾	-	ms6-aend
3	Connecting plate-SET MS6-AG...	-	■ ¹⁾	-	■ ¹⁾	ms6-ag
	Connecting plate-SET MS6-AQ...	-	■ ¹⁾	-	■ ¹⁾	ms6-aq
4	Module connector MS6-MV	-	-	■	■	ms6-mv
5	Mounting bracket MS6-WPB	■	■	■	■	ms6-wpb
6	Mounting bracket MS6-WPE	■	■	■	■	ms6-wpe
7	MS pressure gauge AG/RG	■	■	■	■	44
8	Adapter plate for EN pressure gauge 1/4 A4	■	■	■	■	44
9	Pressure gauge MA	■	■	■	■	61
10	Pressure sensor with LCD display AD1 ... AD4	■	■	■	■	44
11	Connecting cable NEBU-M8...-LE3/NEBU-M12...-LE4	■	■	■	■	61
12	Multi-pin plug socket NECA	■	■	■	■	56
13	AS-i configuration plug CACC	■	■	■	■	59
14	Addressing cable KASI-ADR	■	■	■	■	kasi-asi
15	Addressing device ASI-PRG-ADR	■	■	■	■	asi-prg-adr
16	Silencer UOS-1	■	■	■	■	58
17	Silencer UOS-1-LF	■	■	■	■	58

1) Module connector MS6-MV or mounting bracket MS6-WPB/WPE is required for mounting.

Soft-start and quick exhaust valves MS6-SV-E, MS series

Type codes

MS 6 - SV - 1/2 - E - 10V24 - SO - AG

Series	
MS	Standard service unit
Size	
6	Grid dimension 62 mm
Service function	
SV	Soft-start and quick exhaust valve
Pneumatic connection	
1/2	Female thread G1/2
Performance level	
E	Category 4, 2-channel with self-monitoring, to EN ISO 13849-1
Supply voltage	
10V24	24 V DC
ASIS	22 ... 31.6 V DC, AS-i Safety at Work, SPEC3.0 Profile 7.5.5
Silencer	
	Without silencer
SO	Open silencer
Pressure gauge/pressure gauge alternatives	
AG	MS pressure gauge
AD1	Pressure sensor with LCD display, plug M8, 1 switching output PNP, 3-pin (only with supply voltage 10V24)

Additional variants can be ordered using the modular product system → 44

- Pneumatic connection
- Pressure gauge/pressure gauge alternatives
- Alternative pressure gauge scale
- Multi-pin plug socket
- Type of mounting
- UL certification
- Flow direction

Soft-start and quick exhaust valves MS6-SV-E, MS series

Technical data

Function

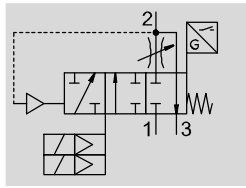

- - Flow rate
4,300 l/min
- - Temperature range
-10 ... +50 °C
- - Operating pressure
3.5 ... 10 bar
- - www.festo.com



The electro-pneumatic soft-start and quick exhaust valve is used to reduce pressure quickly and reliably and to build up pressure gradually in industrial pneumatic systems and terminals. The device is a self-testing, redundant mechatronic system conforming to the

requirements of EN ISO 13849-1. The safety-related pneumatic protection objective of safe venting is also guaranteed in the event of faults inside the valve (e.g. due to wear, contamination, electronic faults). Thanks to the 2-channel design and its monitoring, the device fulfils controller category 3

and 4 requirements. This enables a performance level of max. "e" to be attained. The device receives the secure enable signals (EN1/EN2) via the electrical connection (multi-pin plug socket NECA Sub-D, 9-pin or AS-i connecting cable). The signals in question come

from commercially available electronic or electromechanical safety switching devices which monitor the protective equipment of the machine (e.g. emergency stop, light curtain, electrical door switch of a protective enclosure, etc.).

Note
The MS6-SV-...-E-10V24 must be used in combination with the multi-pin plug socket NECA approved for it. The multi-pin plug socket can be ordered via the modular product system (MP... → 44) or as an accessory (NECA → 56).

Note
To avoid back pressures, it is recommended that the device be operated together with the silencer UOS-1. The silencer can be ordered via the modular product system (SO → 44) or as an accessory (UOS-1 → 58).

Note
Only devices that do not impair the pneumatic protective measure – safe venting – may be placed downstream of the MS6-SV-...-E. The MS6-SV-...-E is not permitted for use as a press safety valve.

- Performance level "e"/category 4 according to EN ISO 13849-1
- Conforms to standard IEC 61508
- Switching time delay adjustable via a flow control valve for gradual pressure build-up
- Optional pressure sensor

Safety characteristics		
Type	MS6-SV-...-E-10V24	MS6-SV-...-E-ASIS
Conforms to standard	EN ISO 13849-1	
Safety function	Exhausting	
	Avoidance of unexpected start-up (pressurisation)	
Performance level (PL)	Exhausting: up to category 4, PL e	
	Avoidance of unexpected start-up (pressurisation): up to category 4, PL e	
Safety integrity level (SIL)	Exhausting: SIL 3	
	Avoidance of unexpected start-up (pressurisation): SIL 3	
Note on forced dynamisation	Switching frequency min. 1/month	
Certificate issuing authority ¹⁾	IFA 1001180	TÜV Nord, Registration no. 44 799 12 556236 000
CE marking (see declaration of conformity) ¹⁾	To EU Machinery Directive	
	To EU EMC Directive	
Shock resistance	Shock test with severity level 2 according to FN 942017-5 and EN 60068-2-27	
Vibration resistance	Transport application test with severity level 2 according to FN 942017-4 and EN 60068-2-6	

1) Additional information www.festo.com/sp → Certificates.

Note on forced dynamisation: switching frequency min. 1/month
The mechanical system is not tested in the controlled (i.e. pressurised) state. If the process-related switching frequency (safe exhausting) is less than once a month, the machine's operator has to carry out a forced switch off.

- Additional functions of MS6-SV-...-E-ASIS:**
- Integrated pressure sensors via AS-i protocol
 - Pressure monitoring (under/over-shooting)

Soft-start and quick exhaust valves MS6-SV-E, MS series

Technical data



Operational principle of the multi-pin plug socket NECA				
Status of enable signal		Status of MS6-SV-...-E-10V24 with multi-pin plug		
EN1	EN2	NECA-...- MP1	NECA-...- MP3	NECA-...- MP5
0 V	0 V	Unpressurized	MS6-SV-...-E-10V24 goes into the fault mode.	MS6-SV-...-E-10V24 does not go into the fault mode, but remains in the safe, unpressurized status. Note: Cross-circuit detection and error detection/evaluation via external controller necessary.
0 V	24 V	MS6-SV-...-E-10V24 goes into the fault mode.	Pressurized	Pressurized
24 V	24 V	Pressurized	MS6-SV-...-E-10V24 goes into the fault mode.	MS6-SV-...-E-10V24 does not go into the fault mode, but remains in the safe, unpressurized status. Note: Cross-circuit detection and error detection/evaluation via external controller necessary.
24 V	0 V	MS6-SV-...-E-10V24 goes into the fault mode.	Unpressurized	Unpressurized

MS6-SV-...-E-10V24 with multi-pin plug socket NECA

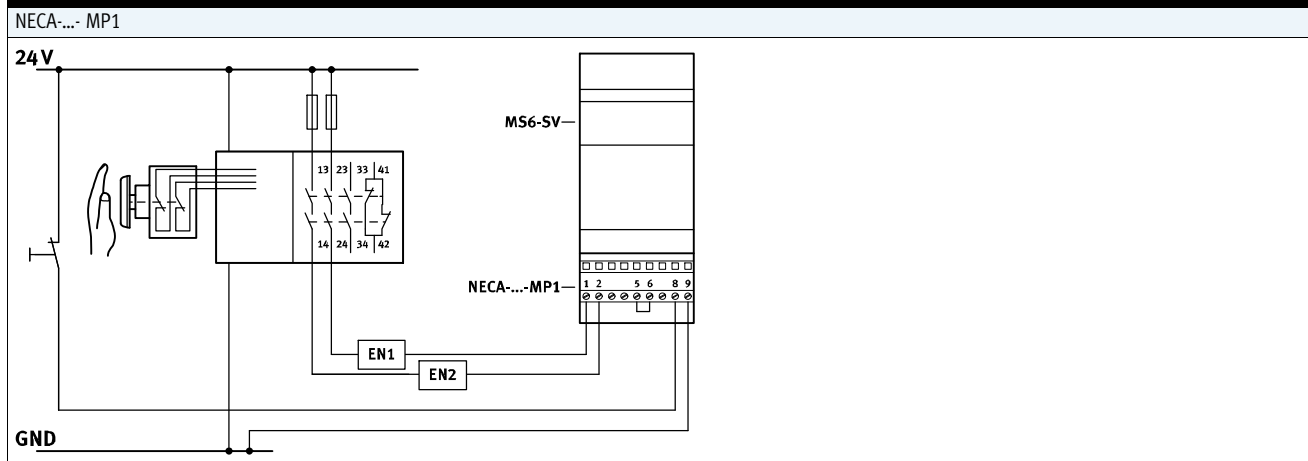

- Static enable signals (EN1 = 24 V, EN2 = 24 V).

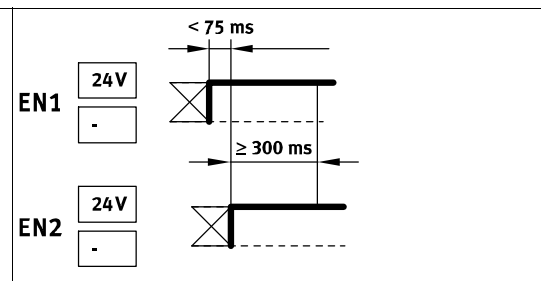

- Clocked enable signals (EN1 = 0 ... 24 V, EN2 = 0 ... 24 V) for cross-circuit detection. Cross-circuit detection with clock signals is in principle carried out by the safety switching device/safety PLC used.





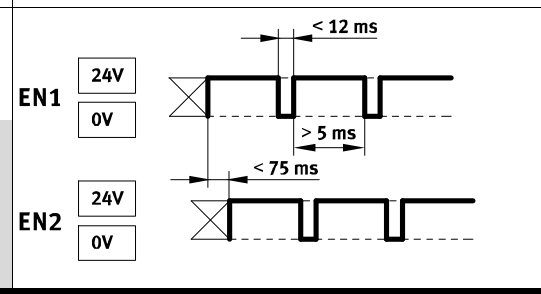

- Note

Given the fact that clock outputs from different controller manufacturers are not standardised, their usability must be checked in each case. If the clock pulse is outside of the described limits, this is recognised by the MS6-SV-...-E-10V24 as an error and a safe switch-off is performed.

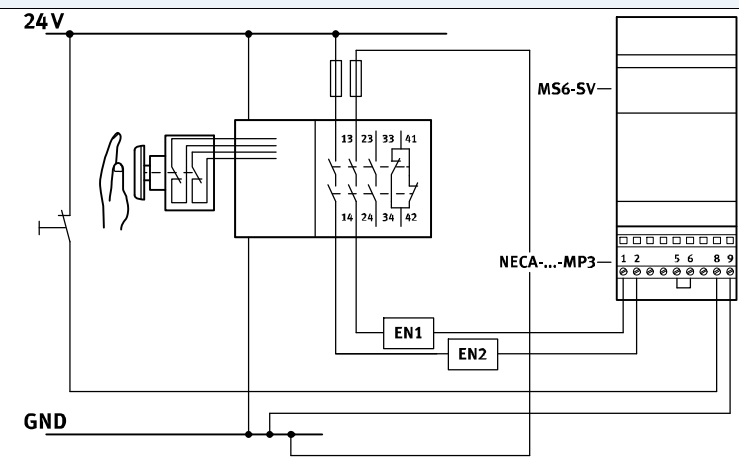

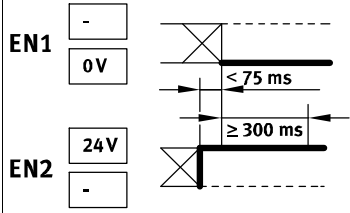
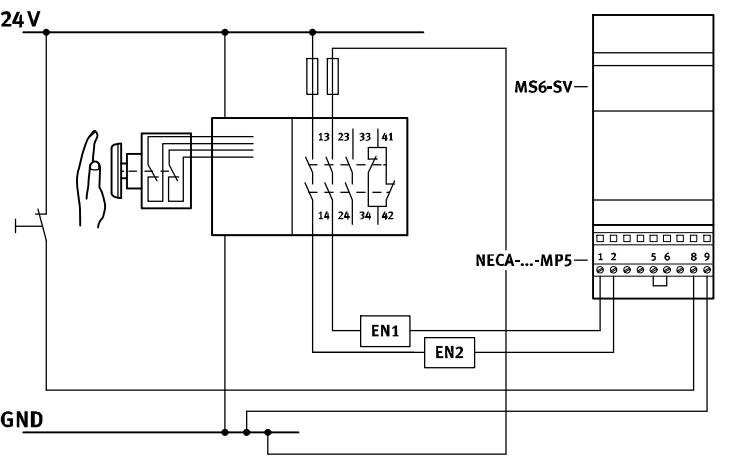
Soft-start and quick exhaust valves MS6-SV-E, MS series

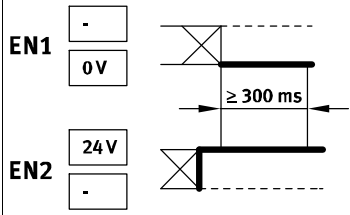
Technical data

MS6-SV...-E-10V24 with multi-pin plug socket NECA	
NECA...- MP3	
	<p>-  Note</p> <p>The multi-pin plug socket NECA-S1G9-P9-MP3 is intended for conventional circuitry with electromechanical safety relays. If problems arise in use with bipolar semiconductor outputs, use the multi-pin plug socket NECA-S1G9-P9-MP5.</p>
<ul style="list-style-type: none"> - Static enable signals with opposite potentials. - The time delay of the level change of the enable signals is monitored. - Behaviour on detection of a cross circuit: <ul style="list-style-type: none"> - MS6-SV...-E-10V24 in the exhausted status: remains in the safe status and goes into the fault mode. - MS6-SV...-E-10V24 in the pressurized status: goes into the safe status and goes into the fault mode. 	
NECA...- MP5	
	<p>-  Note</p> <p>A cross circuit between the enable signals (EN1/EN2) is not detected and does not cause an error response. The system can be pressurized only when the enable signals are applied correctly.</p>
<ul style="list-style-type: none"> - Static enable signals with opposite potentials. - The time delay of the level change of the enable signals is not monitored. - Behaviour on detection of a cross circuit (through upstream safety switching device/safety PLC): <ul style="list-style-type: none"> - MS6-SV...-E-10V24 in the exhausted status: remains in the safe status and does not go into the fault mode. - MS6-SV...-E-10V24 in the pressurized status: goes into the safe status and does not go into the fault mode. - Enable signal are galvanically separated from the supply voltage. 	 <p>-  Note</p> <p>The time delay between EN1 and EN2 must be automatically determined. The duration of the delay is not evaluated.</p>

Soft-start and quick exhaust valves MS6-SV-E, MS series

Technical data

MS6-SV...-E-ASIS in the actuator-sensor interface (AS-i)

The actuator-sensor interface (AS-i) is a system for networking sensors and actuators on the lowest level of the automation hierarchy. It is a non-proprietary, open bus system and enables transfer of data and energy on just one line. This simple method permits an efficient configuration with simultaneously reliable performance. The network topology of the AS-i system can be expanded as desired without any difficulty.

An AS-i network consists of a control

unit, a so-called master and the associated sensor and actuator components, namely the slaves. The master cyclically polls all configured slaves and exchanges input and output data with them. A telegram consists of 4 bits of user data. The master communicates with the slaves via a serial transmission protocol.

AS-i Safety at Work is a certified standard that enables safety-related components to be used in the AS-i system. The safe AS-i system is designed

for safety applications up to category 4 according to EN ISO 13849-1 PL "e". Mixed operation of standard components and safety-oriented components is possible. The AS-interface master considers the safety-oriented slaves just like all other slaves and incorporates them into the network. The transmission protocol and the cables in the AS-i system are laid out so that they are also capable of transmitting safety-oriented telegrams.

The AS-i safety monitor is the central

safe component and monitors the safety-oriented slaves assigned to it within an AS-i system. The safety function is ensured via additional signal transmission between the safety-oriented slaves and the AS-i safety monitor. This transmission takes place with a special safety protocol.

In the case of a stop request or defect, the AS-i safety monitor in protection mode reliably switches the system off with a maximum reaction time of 40 ms.

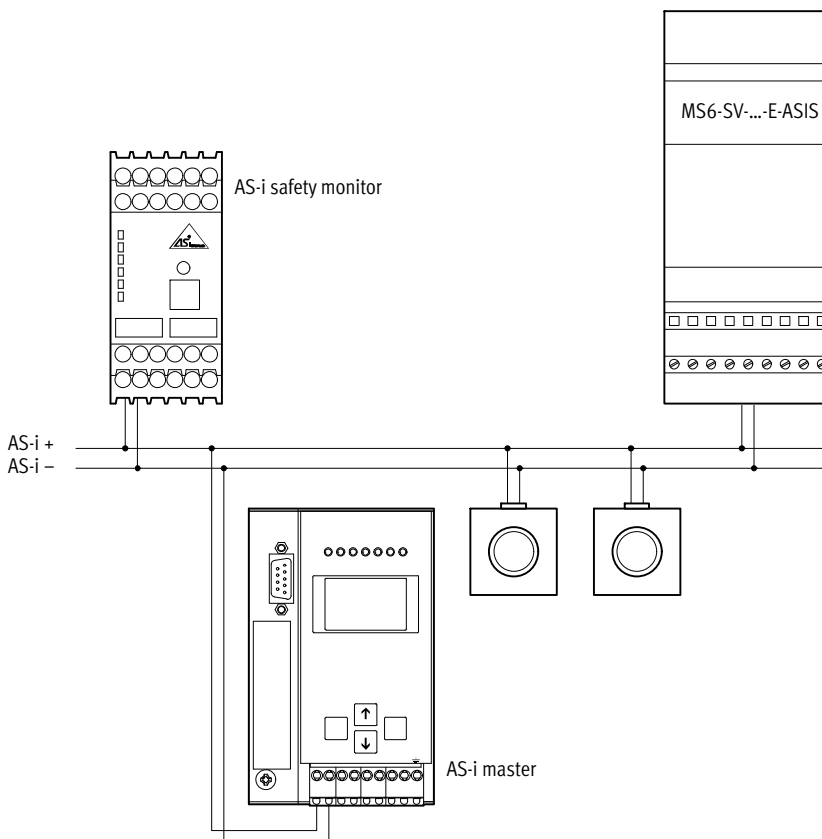

Soft-start and quick exhaust valves MS6-SV-E, MS series

Technical data

General technical data	
Pneumatic connection 1, 2	
Female thread	G $\frac{1}{2}$
Connecting plate AG...	G $\frac{1}{4}$, G $\frac{3}{8}$, G $\frac{1}{2}$ or G $\frac{3}{4}$
Connecting plate AQ...	NPT $\frac{1}{4}$, NPT $\frac{3}{8}$, NPT $\frac{1}{2}$ or NPT $\frac{3}{4}$
Pneumatic connection 3	G1
Actuation type	Electric
Design	Piston seat
Type of mounting	Via accessories In-line installation
Mounting position	Any
Pressure indicator	Via pressure sensor for displaying output pressure via LCD display and electrical output Via pressure gauge for displaying output pressure Via pressure gauge with red/green scale for displaying output pressure G $\frac{1}{4}$ prepared
Position sensing principle	Solenoid piston principle
Valve function	3/2-way valve, closed, single solenoid Soft-start function, adjustable
Non-overlapping	No
Exhaust function	No flow control
Manual override	None
Reset method	Mechanical spring
Type of control	Piloted
Pilot air supply	Internal
Sealing principle	Soft

- | - Note: This product conforms to ISO 1179-1 and to ISO 228-1

Flow rate characteristics	
Pneumatic connection	Female thread G $\frac{1}{2}$
Standard nominal flow rate $q_{nN}^{1)}$ [l/min]	
In main flow direction 1 \rightarrow 2	4,300
Standard flow rate q_N [l/min], $p_2 = 6$ bar	
In venting direction 2 \rightarrow 3	9,000 ²⁾
C value [l/s*min]	
In main flow direction 1 \rightarrow 2	19.3
b value	
In main flow direction 1 \rightarrow 2	0.21

1) Measured at $p_1 = 6$ bar and $p_2 = 5$ bar, $\Delta p = 1$ bar

2) Measured with respect to atmosphere with silencer UOS-1

Electrical data		
Type	MS6-SV-...-E-10V24	MS6-SV-...-E-ASIS
Electrical connection	Sub-D, 9-pin	2x M12
Nominal operating voltage [V DC]	24	-
Permissible voltage [%]	± 10	-
Permissible voltage fluctuations		
Operating voltage range for AS-interface [V DC]	-	22 ... 31.6
Duty cycle [%]	100	
Max. switching frequency [Hz]	1	
Switching time off [ms]	40	
Switching time on [ms]	130	
Signal status display	LED and floating contact	LED and via AS-i
Protection class	IP65 with plug socket	

Soft-start and quick exhaust valves MS6-SV-E, MS series

FESTO

Technical data

AS-i Safety-specific data	
Type	MS6-SV-...-E-ASIS
Fieldbus interface	Socket M12 (AS-i Out) and plug M12 (AS-i In)
LED displays	AS-i and status
Device-specific diagnostics	Inputs for cyclical digital data (exhausted, pressurised, fault) Cyclical analogue values (supply pressure p1, output pressure p2) Acyclical values (counter, pressure monitoring, fault, switching frequency exceeded, status)
Product identification	IO code: 0x7 Profile: 7.5.5 ID code: 0x5 ID1: 0xF ID2: 0x5
Vendor ID AS-interface	0x014D
Device ID AS-interface	0x03A6
Addressing range	Standard slave: 1 ... 31

Operating and environmental conditions		
Type	MS6-SV-...-E-10V24	MS6-SV-...-E-ASIS
Operating pressure [bar]	3.5 ... 10	3.5 ... 10
Operating medium	Compressed air according to ISO 8573-1:2010 [7:4:4]	
Note on operating/pilot medium	Lubricated operation possible (in which case lubricated operation will always be required)	
Ambient temperature [°C]	-10 ... +50 (0 ... +50) ¹⁾	0 ... +50
Temperature of medium [°C]	-10 ... +50 (0 ... +50) ¹⁾	0 ... +50
Storage temperature [°C]	-10 ... +50 (0 ... +50) ¹⁾	0 ... +50
Corrosion resistance class CRC ²⁾	2	
Noise level [dB(A)]	75 (with silencer UOS-1)	
CE marking (see declaration of conformity) ⁴⁾	To EU EMC Directive ³⁾	
	To EU Machinery Directive	
UL certification ⁴⁾	cULus recognized (OL)	
Certification	RCM Mark	
KC marking	KC EMC	

1) With pressure sensor AD...

2) Corrosion resistance class CRC 2 to Festo standard FN 940070

Moderate corrosion stress. Indoor applications in which condensation may occur. External visible parts with primarily decorative requirements for the surface and which are in direct contact with the ambient atmosphere typical for industrial applications.

3) For information about the applicability of the component see the manufacturer's EC declaration of conformity at: www.festo.com/sp → Certificates.

If the component is subject to restrictions on usage in residential, office or commercial environments or small businesses, further measures to reduce the emitted interference may be necessary.

4) Additional information www.festo.com/sp → Certificates.

Weight [g]	
Soft-start and quick exhaust valve	2,000
Soft-start and quick exhaust valve with silencer UOS-1	2,200

Materials	
Housing	Die-cast aluminium
Piston rod	High-alloy stainless steel
Seals	NBR
Note on materials	RoHS-compliant

Soft-start and quick exhaust valves MS6-SV-E, MS series

Technical data

Switching point

Pressure p as a function of time t

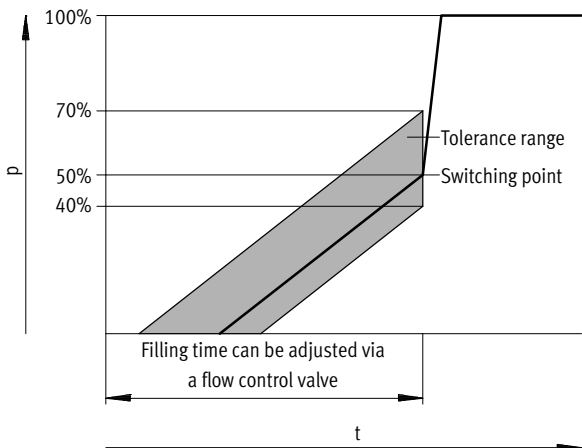

Note
 The +20%/−10% switching point tolerance refers to the operating pressure p1.
 Example: A switching point from 1.6 bar to 2.8 bar is permissible at an operating pressure of 4 bar.

Dimensions – Basic design

Download CAD data → www.festo.com

With supply voltage 10V24,
 with female thread 1/2, with cover plate

With supply voltage ASIS,
 with female thread 1/2, with cover plate

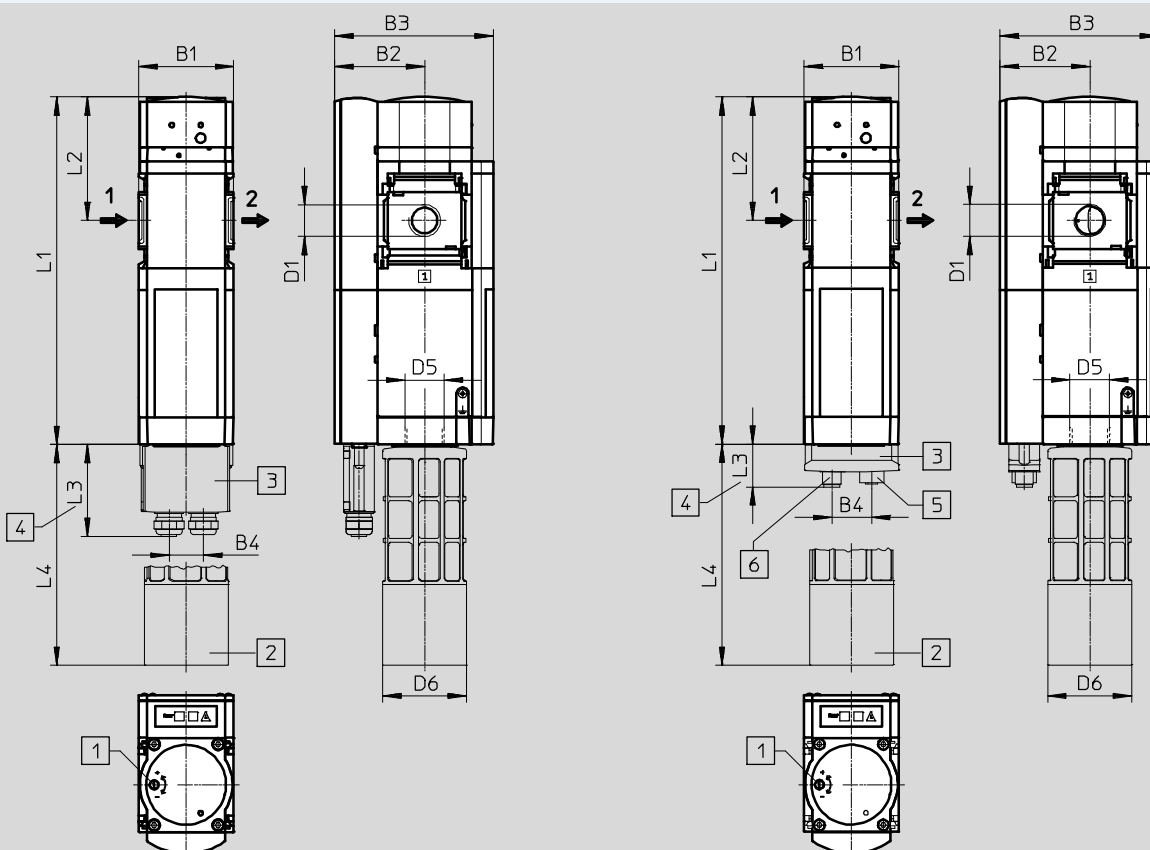

- 1 Regulating screw for flow control valve
 - 2 Silencer UOS-1
 - 3 Multi-pin plug socket NECA or AS-i configuration plug CACC
 - 4 Dimension without cable
 - 5 M12 socket, 5-pin
 - 6 M12 pin, 5-pin
- Flow direction

Type	B1	B2	B3	B4	D1	D5	D6	L1	L2	L3	L4
MS6-SV-1/2-E-10V24	62	59	104	23	G1/2	G1	55	228	81	61	145
MS6-SV-1/2-E-ASIS				26						28	

• Note: This product conforms to ISO 1179-1 and to ISO 228-1

Soft-start and quick exhaust valves MS6-SV-E, MS series

Technical data

Dimensions – Pressure gauge/pressure gauge alternatives Download CAD data → www.festo.com
 Integrated MS pressure gauge with standard scale AG or red/green scale RG, Adapter plate A4 for EN pressure gauge 1/4, without pressure gauge display unit [bar]

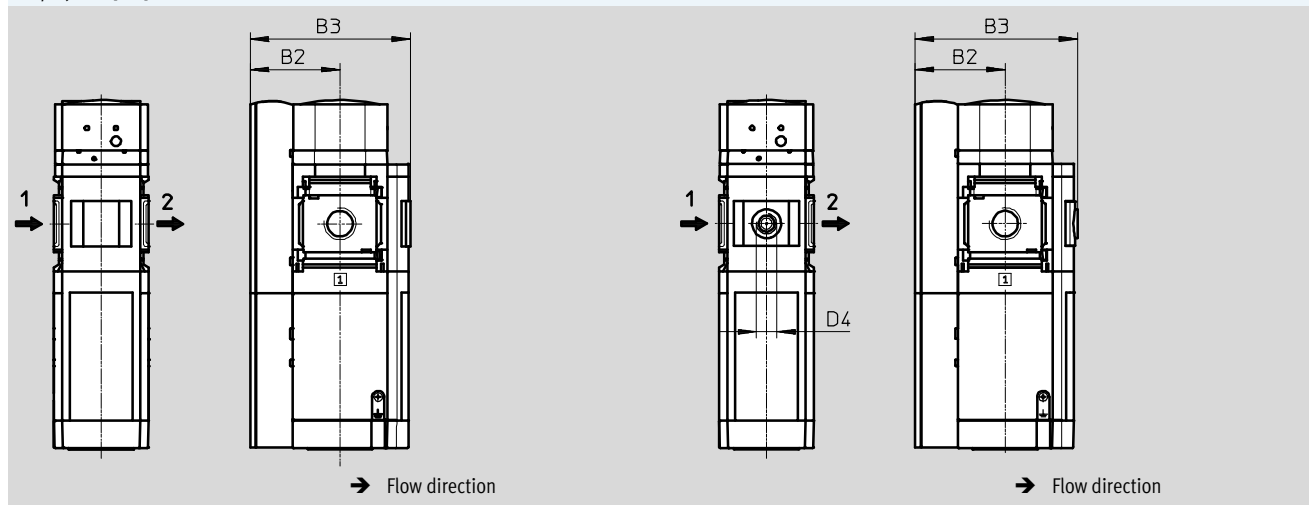

Type	B2	B3	D4
MS6-SV-...-E-...-AG	59	105	-
MS6-SV-...-E-...-RG	59	106.5	-
MS6-SV-...-E-...-A4	59	106.5	G1/4

Note: This product conforms to ISO 1179-1 and to ISO 228-1

Dimensions – Pressure gauge/pressure gauge alternatives Download CAD data → www.festo.com
 Pressure sensor with LCD display AD1 ... AD4 Technical data → Internet: sde1

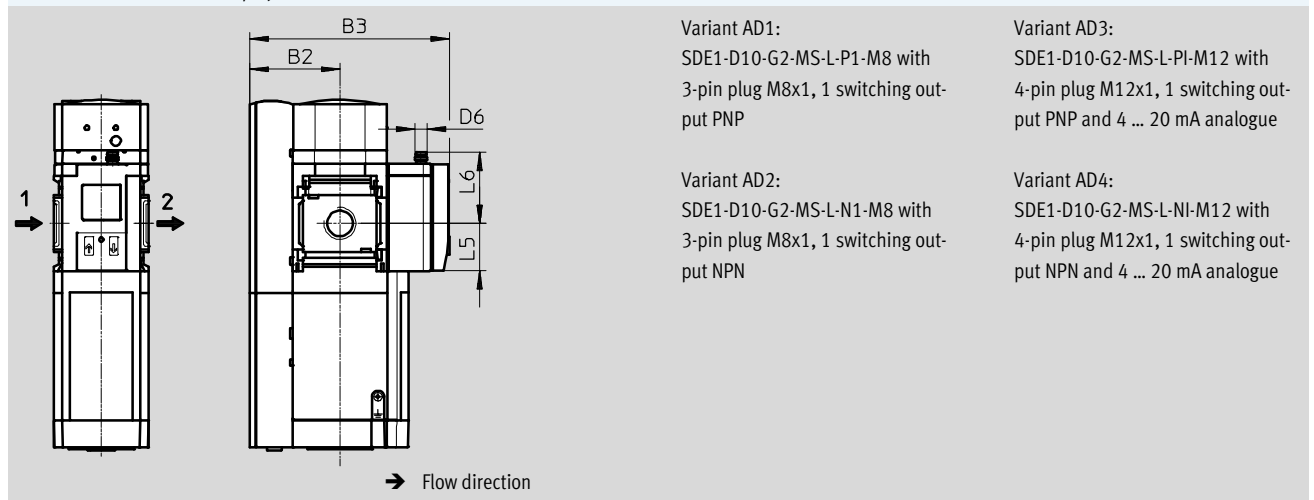

Type	B2	B3	D6	L5	L6
MS6-SV-...-E-...-AD1/AD2	59	131	M8x1	31.2	46.7
MS6-SV-...-E-...-AD3/AD4			M12x1		55.8

Note: This product conforms to ISO 1179-1 and to ISO 228-1

Soft-start and quick exhaust valves MS6-SV-E, MS series

FESTO

Technical data

Ordering data – Supply voltage 10V24					
Size	Connection	Without silencer		With silencer	
		Part No.	Type	Part No.	Type
MS pressure gauge, display unit [bar]					
MS6	G1/2	548715	MS6-SV-1/2-E-10V24-AG	548717	MS6-SV-1/2-E-10V24-SO-AG
Pressure sensor with LCD display, plug M8, PNP, 3-pin					
MS6	G1/2	562580	MS6-SV-1/2-E-10V24-AD1	-	

Ordering data – Supply voltage ASIS					
Size	Connection	Without silencer		With silencer	
		Part No.	Type	Part No.	Type
MS pressure gauge, display unit [bar]					
MS6	G1/2	8001480	MS6-SV-1/2-E-ASIS-AG	8001481	MS6-SV-1/2-E-ASIS-SO-AG

Soft-start and quick exhaust valves MS6-SV-E, MS series



Ordering data – Modular products

M Mandatory data →

Module No.	Series	Size	Function	Pneumatic connection	Performance level	Supply voltage
548713	MS	6	SV	1/2, AG..., AQ...	E	10V24, ASIS
Ordering example						
548713	MS	6	- SV	- AGB	- E	- 10V24

Ordering table

Grid dimension	[mm]	62	Condi- tions	Code	Enter code
M Module No.	548713				
Series	Standard			MS	MS
Size	6			6	6
Function	Soft-start and quick exhaust valve			-SV	-SV
Pneumatic connection	Female thread G1/2			-1/2	
	Connecting plate G1/4			-AGB	
	Connecting plate G3/8			-AGC	
	Connecting plate G1/2			-AGD	
	Connecting plate G3/4			-AGE	
	Connecting plate NPT1/4			-AQN	
	Connecting plate NPT3/8			-AQP	
	Connecting plate NPT1/2			-AQR	
	Connecting plate NPT3/4			-AQS	
	Performance level	Category 4, 2-channel with self-monitoring, to EN ISO 13849-1			-E
Supply voltage	24 V DC (pin allocation to EN 175301)			-10V24	
	22 ... 31.6 V DC, AS-i Safety at Work, SPEC3.0 Profile 7.5.5			-ASIS	

Transfer order code

548713	MS	6	- SV	-	E	-
---------------	-----------	----------	-------------	----------	----------	----------

Soft-start and quick exhaust valves MS6-SV-E, MS series

Ordering data – Modular products

Options						
Silencer	Pressure gauge/ pressure gauge alternatives	Alternative pres- sure gauge scale	Multi-pin plug socket	Type of mounting	UL certification	Flow direction
SO	AG, A4, RG, AD1 ... AD4	PSI, MPA	MP1, MP3, MP5	WPB	UL1	Z
- SO	- AG	-	- MP1	- WPB	-	-

Ordering table					
Grid dimension	[mm]	62	Condi- tions	Code	Enter code
0 Silencer		Open silencer		-SO	
Pressure gauge/pressure gauge alternatives		MS pressure gauge	1	-AG	
		Adapter plate for EN pressure gauge 1/4, without pressure gauge	2	-A4	
		Integrated pressure gauge, red/green scale	1	-RG	
		Pressure sensor with LCD display, plug M8, 1 switching output PNP, 3-pin	2	-AD1	
		Pressure sensor with LCD display, plug M8, 1 switching output NPN, 3-pin	2	-AD2	
		Pressure sensor with LCD display, plug M12, 1 switching output PNP, 4-pin, analogue output 4 ... 20 mA	2	-AD3	
		Pressure sensor with LCD display, plug M12, 1 switching output NPN, 4-pin, ana- logue output 4 ... 20 mA	2	-AD4	
Alternative pressure gauge scale		psi	3	-PSI	
		MPa	4	-MPA	
Multi-pin plug socket		Sub-D, 9-pin, screw terminal, without cable, static enable signals (EN1 = 24 V, EN2 = 24 V)	2	-MP1	
		Sub-D, 9-pin, screw terminal, without cable, static enable signals (EN1 = 0 V, EN2 = 24 V), short-circuit detection possible	2	-MP3	
		Sub-D, 9-pin, screw terminal, without cable, static enable signals (EN1 = 0 V, EN2 = 24 V), galvanic isolation of the enable signals from the supply voltage	2	-MP5	
Type of mounting		Mounting bracket for large wall gap		-WPB	
UL certification		cULus, ordinary location for Canada and USA		-UL1	
Flow direction		Flow direction from right to left		-Z	

- 1 AG, RG Pressure gauge scale in bar
- 2 A4, AD1, AD2, AD3, AD4, MP1, MP3, MP5
Not with supply voltage ASIS.

- 3 PSI Only in combination with pressure gauge AG.
- 4 MPA Only in combination with pressure gauge AG or RG.

Transfer order code

- - - - - - -

Soft-start and quick exhaust valves MS9-SV-C, MS series

Peripherals overview

Soft-start and quick exhaust valve MS9-SV-C

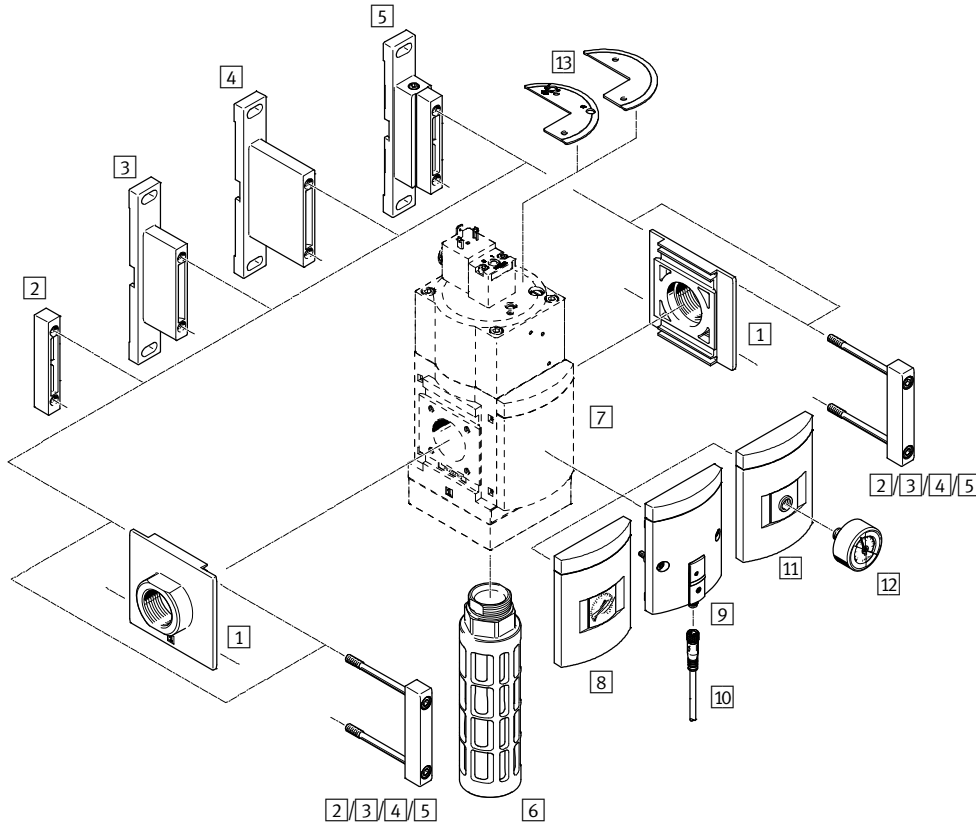

-  - Note
 Additional accessories:
 - Module connector for combination with size MS6, MS9 or MS12
 → Internet: rmv, armv

Supply voltage
 V24/V110/V230

Supply voltage
 10V24P

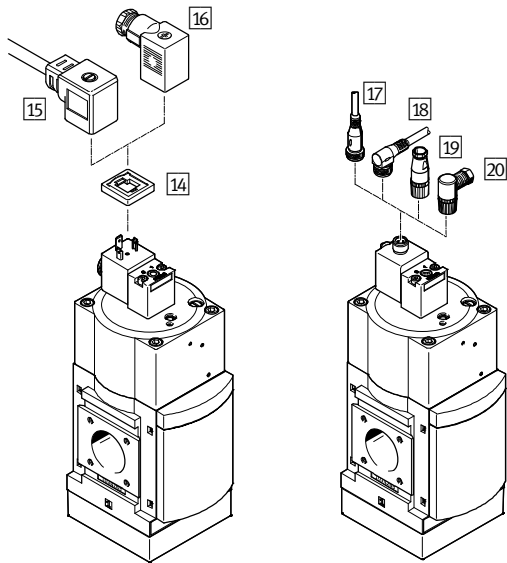

Soft-start and quick exhaust valves MS9-SV-C, MS series

FESTO

Peripherals overview

Mounting attachments and accessories					
		Individual device		Combination	→ Page/ Internet
		With female thread 3/4/1/N3/4/N1	With connecting plate AG.../AQ...	Module without connecting thread, without connecting plate G/NG	
1	Connecting plate-SET MS9-AG...	-	■	■	ms9-ag
	Connecting plate-SET MS9-AQ...	-	■	■	ms9-aq
2	Module connector MS9-MV	-	-	■	ms9-mv
3	Mounting bracket MS9-WP	■	■	■	ms9-wp
4	Mounting bracket MS9-WPB	■	■	■	ms9-wp
5	Mounting bracket MS9-WPM	■	■	■	ms9-wp
6	Silencer U-1-B	■	■	■	60
7	Cover plate VS	■	■	■	54
8	MS pressure gauge AG/RG	■	■	■	54
9	Pressure sensor with operational status indicator AD7 ... AD10	■	■	■	54
10	Connecting cable NEBU-M8...-LE3	■	■	■	61
11	Adapter plate for EN pressure gauge 1/4 A4	■	■	■	54
12	Pressure gauge MA	■	■	■	61
13	Cover MS9-SV-MH/MK	■	■	■	59
14	Illuminating seal MC-LD	■	■	■	61
15	Connecting cable KMC	■	■	■	60
16	Plug socket MSSD-C	■	■	■	60
17	Connecting cable NEBU-M12G5	■	■	■	61
18	Connecting cable NEBU-M12W5	■	■	■	61
19	Sensor socket SIE-GD	■	■	■	61
20	Angled socket SIE-WD	■	■	■	61

Soft-start and quick exhaust valves MS9-SV-C, MS series

Type codes

		MS	9	-	SV	-	G	-	C	-	V24	-	S	-	VS
Series															
MS	Standard service unit														
Size															
9	Grid dimension 90 mm														
Service function															
SV	Soft-start and quick exhaust valve														
Pneumatic connection															
G	Module without connecting thread, without connecting plate														
Performance level															
C	Category 1, to EN ISO 13849-1														
Supply voltage															
V24	Supply voltage 24 V DC														
Silencer															
S	Silencer														
Pressure gauge/pressure gauge alternatives															
VS	Cover plate														

Additional variants can be ordered using the modular product system → 54

- Pneumatic connection
- Supply voltage
- Pressure gauge/pressure gauge alternatives
- Alternative pressure gauge scale
- Type of mounting
- Tamper protection
- Flow direction

Soft-start and quick exhaust valves MS9-SV-C, MS series

Technical data

Function

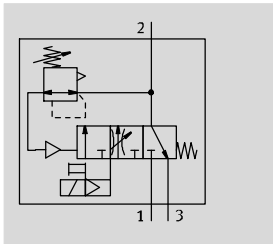

- - Flow rate
8,300 ... 16,550 l/min
- - Temperature range
0 ... +60 °C
- - Operating pressure
3.5 ... 16 bar
- - www.festo.com



Electro-pneumatic soft-start and quick exhaust valve for gradual pressurisation and quick exhausting of system components (single channel).

The main flow control valve in the end cap permits a gradual build-up of output pressure p2. Once the output pressure p2 has reached the set pressure switchover point (switching pressure), the valve opens and the full operating pressure p1 is present at the output.

- Suitable for applications with high flow rates and restricted space with medium safety requirements up to controller category 1, performance level "c"
- High volumetric flow rate for pressurisation and venting
- The filling flow rate can be set via a flow control valve for gradual pressure build-up
- Adjustable pressure switchover point
- Optional pressure sensor
- Optional cover for the control sections as tamper protection

Safety characteristics	
Conforms to standard	EN ISO 13849-1
Safety function	Venting
Performance level (PL)	Venting: up to category 1, PL c
Shock resistance	Shock test with severity level 1 according to FN 942017-5 and EN 60068-2-27
Vibration resistance	Transport application test with severity level 1 to FN 942017-4 and EN 60068-2-6

General technical data	
Pneumatic connection 1, 2	
Female thread	G3/4, G1, NPT3/4 or NPT1
Connecting plate AG...	G1/2, G3/4, G1, G1 1/4 or G1 1/2
Connecting plate AQ...	NPT1/2, NPT3/4, NPT1, NPT1 1/4 or NPT1 1/2
Module without connecting thread/plate G/NG	-
Pneumatic connection 3	G1 (NPT1) ¹⁾
Actuation type	Electric
Design	Piston spool valve
Type of mounting	Via accessories In-line installation
Mounting position	Any
Pressure indicator	Via pressure sensor for displaying output pressure via operational status indicator and electrical output Via pressure gauge for displaying output pressure Via pressure gauge with red/green scale for displaying output pressure G1/4 prepared
Valve function	3/2-way valve, closed, single solenoid Soft-start function, adjustable
Exhaust function	No flow control
Reset method	Mechanical spring
Type of control	Piloted
Sealing principle	Soft

1) Only with N3/4/N1/AQ.../NG without silencer S
 - - Note: This product conforms to ISO 1179-1 and to ISO 228-1

Soft-start and quick exhaust valves MS9-SV-C, MS series

Technical data

FESTO

Electrical data		
Coil characteristics	V24	24 V DC: 8.4 W; permissible voltage fluctuations $\pm 10\%$
	10V24P	24 V DC: 2.7 W; permissible voltage fluctuations $\pm 10\%$
	V110	110 V AC: 50/60 Hz; pick-up power 14.5 VA; holding power 10.5 VA; permissible voltage fluctuations $\pm 10\%$
	V230	230 V AC: 50/60 Hz; pick-up power 14.5 VA; holding power 10.5 VA; permissible voltage fluctuations $\pm 10\%$
Electrical connection	V24, V110, V230	Plug, square design to EN 175301-803, type A
	10V24P	M12x1, 4-pin, to IEC 61076-2-101, to DESINA
Protection class	IP65 with plug socket	
Duty cycle	[%]	100

Flow rate characteristics							
Pneumatic connection	Female thread		Connecting plate				
	$\frac{3}{4}/N\frac{3}{4}$	1/N1	AGD/AQR	AGE/AQS	AGF/AQT	AGG/AQU	AGH/AQV
Standard nominal flow rate $q_{nN}^{1)}$ [l/min]							
In main flow direction 1 \rightarrow 2	14,150	16,460	8,300	13,250	16,340	16,550	15,910
Standard flow rate q_n [l/min]							
For exhaust 6 \rightarrow 0 bar with silencer S	21,450	20,870	21,720	20,900	20,370	19,730	19,850
C value [l/s*min]							
In main flow direction 1 \rightarrow 2	57.61	69.59	31.43	54.24	68.24	68.45	66.07
In venting direction 2 \rightarrow 3	55.52	54.01	56.22	54.07	52.73	51.06	51.36
b value							
In main flow direction 1 \rightarrow 2	0.37	0.32	0.47	0.37	0.34	0.35	0.35
In venting direction 2 \rightarrow 3	0.49	0.46	0.60	0.49	0.47	0.45	0.44

1) Measured at $p_1 = 6$ bar and $p_2 = 5$ bar, $\Delta p = 1$ bar

Operating and environmental conditions			
Variant	Coil characteristic V24	Coil characteristic 10V24P	Coil characteristic V110, V230
Operating pressure [bar]	3.5 ... 16 (3.5 ... 10) ²⁾		3.5 ... 16 (3.5 ... 10) ²⁾
Operating medium	Compressed air according to ISO 8573-1:2010 [7:4:4]		
Note on operating/pilot medium	Operation with lubricated medium possible (in which case lubricated operation will always be required)		
Ambient temperature [°C]	0 ... +60 (0 ... +50) ²⁾		
Temperature of medium [°C]	0 ... +60 (0 ... +50) ²⁾		
Storage temperature [°C]	0 ... +60 (0 ... +50) ²⁾		
Corrosion resistance class CRC ¹⁾	2		
Noise level ³⁾ [dB(A)]	93 (with silencer S)		
CE marking (see declaration of conformity)	-		To EU Low Voltage Directive

- 1) Corrosion resistance class CRC 2 to Festo standard FN 940070
Moderate corrosion stress. Indoor applications in which condensation may occur. External visible parts with primarily decorative requirements for the surface and which are in direct contact with the ambient atmosphere typical for industrial applications.
- 2) With pressure sensor AD...
- 3) Venting at 10 bar at a distance of 1 m

Weight [g]	
Soft-start/quick exhaust valve	2,970
Soft-start/quick exhaust valve with silencer S	3,200

Soft-start and quick exhaust valves MS9-SV-C, MS series

Technical data

Materials

Sectional view

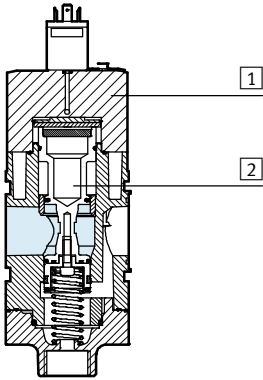

Soft-start and quick exhaust valve

1	Housing	Die-cast aluminium
2	Piston spool	Brass
-	Seals	NBR
Note on materials		RoHS-compliant

Adjusting elements

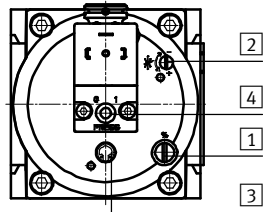

- 1 Screw for adjusting the pressure switchover point
- 2 Flow control screw for adjusting the filling time
- 3 Manual override at the soft-start and quick exhaust valve:
 - Detenting/self-resetting as soon as the solenoid coil or manual override at the pilot solenoid valve is actuated.
- 4 Manual override at the pilot solenoid valve:
 - Non-detenting, actuation from above

Dimensions – Basic design

Download CAD data → www.festo.com

Module without connecting thread, without connecting plate G/NG, with cover plate VS

Supply voltage V24/V110/V230

Supply voltage 10V24P

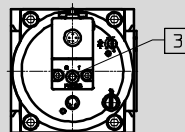
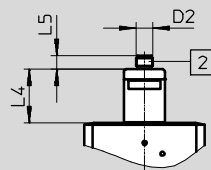
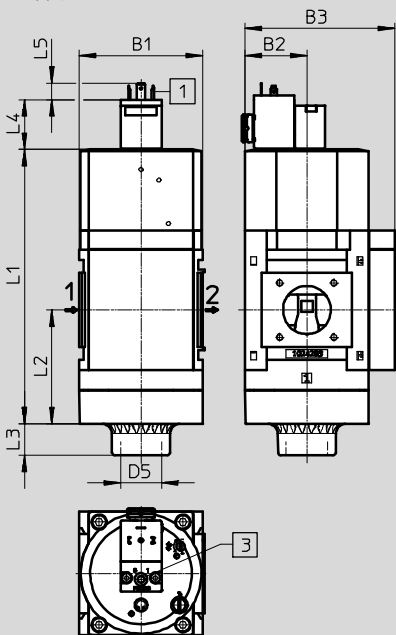

With silencer S

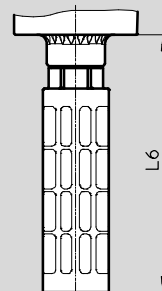

- 1 Plug connection to EN 175301-803
 - 2 Electrical connection to IEC 61076-2-101, plug M12x1, 4-pin to DESINA
 - 3 Manual override
- Flow direction

Type	B1	B2	B3	D2	D5	L1	L2	L3	L4	L5	L6
MS9-SV-G/NG-...-V24/V110/V230	90	45	109	-	G1 (NPT1) ¹⁾	200	83	23	36.4	12	189
MS9-SV-G/NG-...-10V24P				M12x1					39.2	10	

1) Only with N3/4/N1/AQ.../NG without silencer S

Soft-start and quick exhaust valves MS9-SV-C, MS series

Technical data

Dimensions – Connecting thread/connecting plate Download CAD data → www.festo.com

With female thread 3/4/1/N3/4/N1 With connecting plate AG.../AQ...

1 Mounting screw M6x11.90 to DIN 912 (not included in the scope of delivery) for wall mounting without mounting bracket

→ Flow direction

Type	B4	B5	B6	B7	B8	D1	D6	D7	L6	T1	∅
MS9-SV-3/4	90	104	91.5	-	-	G3/4	11	6.5	66	6	-
MS9-SV-1						G1					
MS9-SV-AGD	-	-	-	112	132	G1/2	-	-	-	-	30
MS9-SV-AGE					132	G3/4					36
MS9-SV-AGF					142	G1					41
MS9-SV-AGG					162	G1 1/4					50
MS9-SV-AGH					176	G1 1/2					55
MS9-SV-N3/4	90	104	91.5	-	-	NPT3/4-14	11	6.5	66	6	-
MS9-SV-N1						NPT1-11 1/2					
MS9-SV-AQR	-	-	-	112	132	NPT1/2-14	-	-	-	-	30
MS9-SV-AQS					132	NPT3/4-14					36
MS9-SV-AQT					142	NPT1-11 1/2					41
MS9-SV-AQU					162	NPT1 1/4-11 1/2					50
MS9-SV-AQV					176	NPT1 1/2-11 1/2					55

Note: This product conforms to ISO 1179-1 and to ISO 228-1

Soft-start and quick exhaust valves MS9-SV-C, MS series

Technical data

Dimensions – Pressure gauge/pressure gauge alternatives Download CAD data → www.festo.com
 Integrated MS pressure gauge with standard scale AG or red/green scale RG Adapter plate A4 for EN pressure gauge 1/4, without pressure gauge

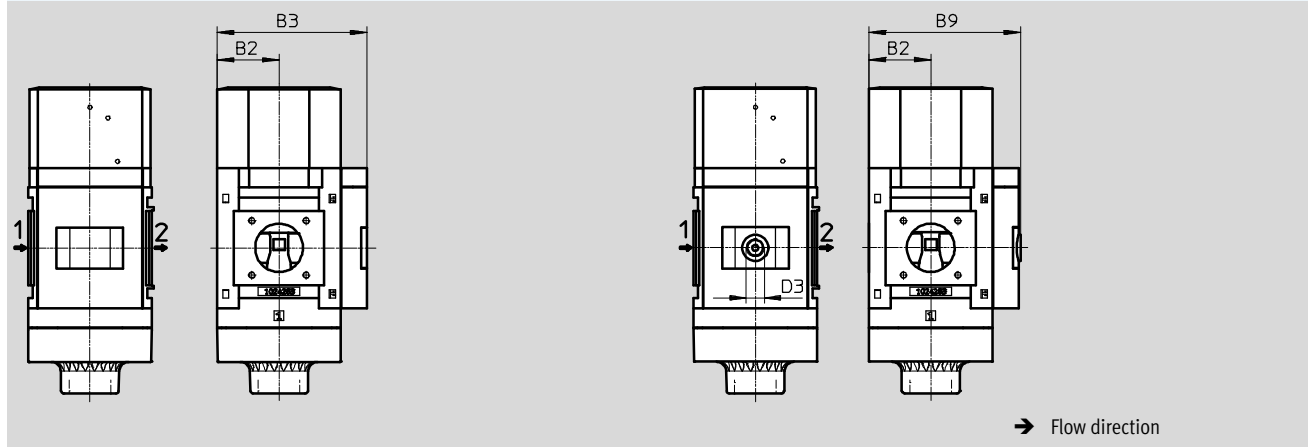

Type	B2	B3	B9	D3
MS9-SV-...-AG/RG	45	109	–	–
MS9-SV-...-A4		–	110	G1/4

– | – Note: This product conforms to ISO 1179-1 and to ISO 228-1

Dimensions – Pressure gauge/pressure gauge alternatives Download CAD data → www.festo.com
 Pressure sensor with operational status indicator AD7 ... AD10 Technical data → Internet: [sde5](http://sde5.festo.com)

Variant AD7:
SDE5-D10-O-...-P-M8 with 3-pin plug M8x1, threshold value comparator, 1 switching output PNP, N/O contact

Variant AD8:
SDE5-D10-C-...-P-M8 with 3-pin plug M8x1, threshold value comparator, 1 switching output PNP, N/C contact

Variant AD9:
SDE5-D10-O3-...-P-M8 with 3-pin plug M8x1, window comparator, 1 switching output PNP, N/O contact

Variant AD10:
SDE5-D10-C3-...-P-M8 with 3-pin plug M8x1, window comparator, 1 switching output PNP, N/C contact

Type	B2	B11	D3
MS9-SV-...-AD7/AD8/AD9/AD10	45	112	M8

Ordering data			
Size	Connection	With silencer	
		Part No.	Type
Cover plate			
MS9	–	570737	MS9-SV-G-C-V24-S-VS

Soft-start and quick exhaust valves MS9-SV-C, MS series



Ordering data – Modular products

M Mandatory data →

Module No.	Series	Size	Function	Pneumatic connection	Performance level	Supply voltage
562176	MS	9	SV	¾, 1, AG..., N¾, N1, AQ..., G, NG	C	V24, 10V24P, V110, V230
Ordering example						
562176	MS	9	- SV	- 1	- C	- V24

Ordering table

Grid dimension	[mm]	90	Conditions	Code	Enter code
M Module No.	562176				
Series	Standard			MS	MS
Size	9			9	9
Function	Soft-start and quick exhaust valve			-SV	-SV
Pneumatic connection	Female thread G¾			-¾	
	Female thread G1			-1	
	Connecting plate G½			-AGD	
	Connecting plate G¾			-AGE	
	Connecting plate G1			-AGF	
	Connecting plate G1¼			-AGG	
	Connecting plate G1½			-AGH	
	Female thread NPT¾			-N¾	
	Female thread NPT1			-N1	
	Connecting plate NPT½			-AQR	
	Connecting plate NPT¾			-AQS	
	Connecting plate NPT1			-AQT	
	Connecting plate NPT1¼			-AQU	
	Connecting plate NPT1½			-AQV	
	Module without connecting thread, without connecting plate			-G	
	Module without connecting thread, without connecting plate			-NG	
Performance level	Category 1, 1-channel, to EN ISO 13849-1			-C	-C
Supply voltage	24 V DC (pin allocation to EN 175301), 16 bar			-V24	
	24 V DC, M12 to IEC 61076-2-101, 10 bar			-10V24P	
	110 V AC (pin allocation to EN 175301), 16 bar			-V110	
	230 V AC (pin allocation to EN 175301), 16 bar			-V230	

Transfer order code

562176	MS	9	- SV	-		- C	-	
---------------	-----------	----------	-------------	---	--	------------	---	--

Soft-start and quick exhaust valves MS9-SV-C, MS series

Ordering data – Modular products

→ [0]	[M]	[0] Options				→
Silencer	Pressure gauge/ pressure gauge alternatives	Alternative pressure gauge scale	Type of mounting	Tamper protection	Flow direction	
S	AG, VS, A4, RG, AD7 ... AD10	PSI, MPA, BAR	WP, WPM, WPB	MH, MK	Z	
- S	- AG	-	-	-	-	

Ordering table		Grid dimension [mm]	90	Condi- tions	Code	Enter code
[0]	Silencer	Silencer			-S	
[M]	Pressure gauge/pressure gauge alternatives	MS pressure gauge			-AG	
		Cover plate			-VS	
		Adapter plate for EN pressure gauge 1/4, without pressure gauge			-A4	
		Integrated pressure gauge, red/green scale		[1]	-RG	
		Pressure sensor with operational status indicator, plug M8, threshold value comparator, PNP, N/O contact		[2]	-AD7	
		Pressure sensor with operational status indicator, plug M8, threshold value comparator, PNP, N/C contact		[2]	-AD8	
		Pressure sensor with operational status indicator, plug M8, window comparator, PNP, N/O contact		[2]	-AD9	
		Pressure sensor with operational status indicator, plug M8, window comparator, PNP, N/C contact		[2]	-AD10	
[0]	Alternative pressure gauge scale	psi		[3]	-PSI	
		MPa		[3]	-MPA	
		bar		[3]	-BAR	
	Type of mounting	Mounting bracket standard design		[4]	-WP	
		Mounting bracket for attaching the service units		[4]	-WPM	
		Mounting bracket for large wall gap		[4]	-WPB	
	Tamper protection	Without manual override (manual override at soft-start/quick exhaust valve locked, adjusting screws open, manual override at pilot solenoid valve locked)			-MH	
		Complete (manual override at soft-start/quick exhaust valve locked, adjusting screws locked, manual override at pilot solenoid valve locked)			-MK	
	Flow direction	Flow direction from right to left			-Z	

- [1] RG** Not with alternative pressure gauge scale PSI, PSI scale serves only as an auxiliary scale (inner scale), outer scale in bar
- [2] AD7, AD8, AD9, AD10** Measuring range max. 10 bar
- [3] PSI, MPA, BAR** Only in combination with pressure gauge AG or RG.
- [4] WP, WPM, WPB** Not with pneumatic connection G, NG

Transfer order code

- **S** - - - - -

Soft-start and quick exhaust valves MS-SV, MS series

FESTO

Accessories

Multi-pin plug socket NECA

(order code in the modular product system: MP1/MP3/MP5)

- For soft-start and quick exhaust valve MS6-SV-E-10V24



Technical data		
Type of mounting		Via through-hole
Electrical connection 1		Sub-D 9-pin
Electrical connection 2		Screw terminal 9-pin
Operating voltage range	[V DC]	21.6 ... 26.4
Nominal operating voltage	[V DC]	24
Acceptable current load	[A]	1.0
Connection cross section	[mm ²]	0.34 ... 1.0 without wire end sleeves
	[mm ²]	0.34 ... 0.5 with wire end sleeves
Permissible cable diameter	[mm]	5.0 ... 10.0
Protection class to IEC 60529		IP65

Operating and environmental conditions		
Relative air humidity		95%, non-condensing
Ambient temperature	[°C]	0 ... +50
Storage temperature	[°C]	-20 ... +70
Corrosion resistance class CRC ¹⁾		2

1) Corrosion resistance class CRC 2 to Festo standard FN 940070

Moderate corrosion stress. Indoor applications in which condensation may occur. External visible parts with primarily decorative requirements for the surface and which are in direct contact with the ambient atmosphere typical for industrial applications.

Materials	
Housing	PA reinforced
Screws	Steel
Union nut	Brass
Seals	NBR

Soft-start and quick exhaust valves MS-SV, MS series

Accessories

Dimensions

Download CAD data → www.festo.com

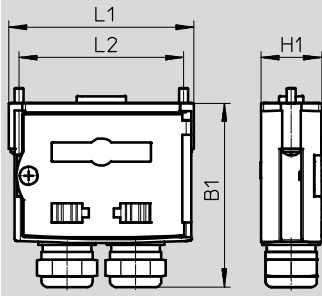

B1	H1	L1	L2
61	20	61	54.1

Ordering data

Description	Connection	Weight [g]	Part No.	Type
For MS6-SV-E-10V24	Without cable, static enable signals (EN1 = 24 V, EN2 = 24 V)	60	548719	NECA-S1G9-P9-MP1
	Without cable, static enable signals (EN1 = 0 V, EN2 = 24 V), cross-circuit detection possible	60	552703	NECA-S1G9-P9-MP3
	Without cable, static enable signals (EN1 = 0 V, EN2 = 24 V), galvanic isolation of the enable signals from the supply voltage	60	573695	NECA-S1G9-P9-MP5

Soft-start and quick exhaust valves MS-SV, MS series

Accessories

Silencer UOS-1

(order code in the modular product system: S0)

- For soft-start and quick exhaust valve MS6-SV-D/E

Silencer UOS-1-LF

- For soft-start and quick exhaust valve MS6-SV-D/E

 Note

The space-saving silencer UOS-1-LF may only be used for applications with low exhaust rates. Pneumatic port 2 at the soft-start and quick exhaust valve MS6-SV-D/E must be reduced to G $\frac{1}{4}$ using a connecting plate MS6-AGB.



Technical data	
Pneumatic connection	G1
Design	Open silencer
Type of mounting	Via male thread
Mounting position	Any
Type of seal on threaded collar	No seal

Operating and environmental conditions	
Operating pressure [bar]	0 ... 10
Operating medium	Compressed air to ISO 8573-1:2010 [-:-:-]
Ambient temperature [°C]	-10 ... +50
Corrosion resistance class CRC ¹⁾	2

1) Corrosion resistance class CRC 2 to Festo standard FN 940070
Moderate corrosion stress. Indoor applications in which condensation may occur. External visible parts with primarily decorative requirements for the surface and which are in direct contact with the ambient atmosphere typical for industrial applications.

Materials		
Type	UOS-1	UOS-1-LF
Housing	POM	Wrought aluminium alloy
Sleeve	Wrought aluminium alloy	-
Silencer insert	PE	
Note on materials	RoHS-compliant	
	Free of copper and PTFE	

Dimensions Download CAD data → www.festo.com

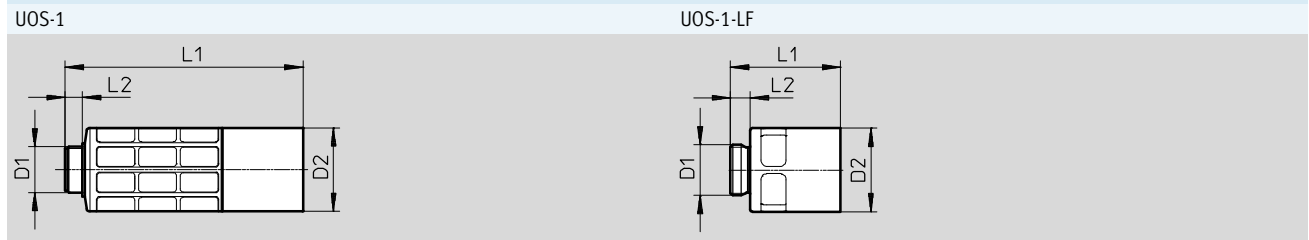

Type	D1	D2	L1	L2
UOS-1	G1	∅	156.5	11.5
UOS-1-LF		55	72.2	13

Ordering data				
Description		Weight [g]	Part No.	Type
For MS6-SV-D/E	For high exhaust rate	200	552252	UOS-1
	For low exhaust rate	157.9	1901207	UOS-1-LF

Soft-start and quick exhaust valves MS-SV, MS series

Accessories

AS-i configuration plug CACC

- For soft-start and quick exhaust valve MS6-SV-E-ASIS

Note on materials: RoHS-compliant

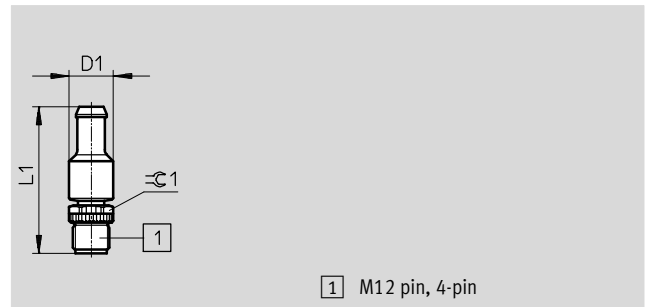

1 M12 pin, 4-pin

Dimensions and ordering data					
Description	D1	L1	≈G1	Part No.	Type
For MS6-SV-E-ASIS	14.5	48.3	13	573923	CACC-CP-AS

Cover MS-SV-MH/MK

(order code in the modular product system: MH/MK)

- For soft-start and quick exhaust valve MS6/9-SV-C

Note on materials: RoHS-compliant



MS6-SV-C-MK



MS9-SV-MK



MS9-SV-MH

Ordering data					
Description		CRC ¹⁾	Part No.	Type	
For MS6-SV-C	Tamper protection for manual override at the soft-start and quick exhaust valve, flow control screw, adjusting screw for pressure switchover point and manual override at the pilot solenoid valve (MS6-SV-...-C-10V24/10V24P only)	2	8001479	MS6-SV-C-MK	
For MS9-SV-C	Tamper protection for manual override at the soft-start and quick exhaust valve, flow control screw, adjusting screw for pressure switchover point and manual override at the pilot solenoid valve	2	1457669	MS9-SV-MK	
	Tamper protection for manual override at the soft-start and quick exhaust valve and manual override at the pilot solenoid valve	2	1457670	MS9-SV-MH	

1) Corrosion resistance class CRC 2 to Festo standard FN 940070
Moderate corrosion stress. Indoor applications in which condensation may occur. External visible parts with primarily decorative requirements for the surface and which are in direct contact with the ambient atmosphere typical for industrial applications.

Soft-start and quick exhaust valves MS-SV, MS series

FESTO

Accessories

Ordering data – Silencer U-...-B				Technical data → Internet: u	
	Description	Pneumatic connection	Order code in the modular product system	Part No.	Type
	For MS6-SV-C	G3/4	S	6845	U-3/4-B
	For MS9-SV-C	G1	S	151990	U-1-B

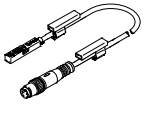
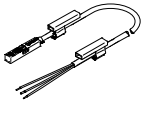
Ordering data – Proximity sensor SMT						Technical data → Internet: smt		
	Description	Switching output	Switching element function	Electrical connection	Cable length [m]	Order code in the modular product system	Part No.	Type
	For MS6-SV-D	PNP	N/O contact	Cable with plug M8x1, 3-pin	0.3	2M8/S3	★ 574334	SMT-8M-A-PS-24V-E-0,3-M8D
				Cable with plug M12x1, 3-pin	0.3	2M12/S3	★ 574337	SMT-8M-A-PS-24V-E-0,3-M12
	For MS6-SV-D	PNP	N/O contact	Cable, 3-wire	5	20E/S3	★ 574336	SMT-8M-A-PS-24V-E-5,0-OE

Ordering data – Plug socket MSSD				Technical data → Internet: mssd	
	Description	Electrical connection	Type of mounting for cable connection	Part No.	Type
	For MS6-SV-C/D	3-pin	Clamping screws	★ 151687	MSSD-EB
		4-pin	Insulation displacement connectors	192745	MSSD-EB-S-M14
	For MS9-SV-C	3-pin	Clamping screws	539712	MSSD-EB-M12
		3-pin	Clamping screws	34583	MSSD-C
		4-pin	Insulation displacement connectors	192748	MSSD-C-S-M16
		4-pin	Insulation displacement connectors	192748	MSSD-C-S-M16

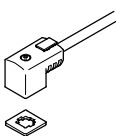
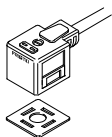
Ordering data – Plug socket with cable KMEB/connecting cable KMC						Technical data → Internet: kmeb, kmc	
	Description	Operating voltage	Electrical connection	Switching status display	Cable length [m]	Part No.	Type
	For MS6-SV-C/D	24 V DC	2-pin	LED	2.5	547268	KMEB-3-24-2,5-LED
				–	5	547269	KMEB-3-24-5-LED
				–	2.5	547270	KMEB-3-24-2,5
			3-pin	LED	5	547271	KMEB-3-24-5
				LED	2.5	★ 151688	KMEB-1-24-2,5-LED
				LED	5	151689	KMEB-1-24-5-LED
		230 V AC	3-pin	–	10	193457	KMEB-1-24-10-LED
				–	2.5	151690	KMEB-1-230AC-2,5
			3-pin	–	5	151691	KMEB-1-230AC-5
				–	5	151691	KMEB-1-230AC-5
	For MS9-SV-C	24 V DC	3-pin	LED	2.5	30931	KMC-1-24DC-2,5-LED
					5	30933	KMC-1-24DC-5-LED
					10	193459	KMC-1-24-10-LED
		230 V AC	3-pin	–	2.5	30932	KMC-1-230AC-2,5
					5	30934	KMC-1-230AC-5
					5	30934	KMC-1-230AC-5

Festo core product range



- ★ Generally ready for shipping ex works in 24 hours
- ☆ Generally ready for shipping ex works in 5 days



Soft-start and quick exhaust valves MS-SV, MS series

FESTO

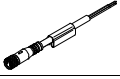
Accessories

Ordering data – Illuminating seal MEB-LD/MC-LD				Technical data → Internet: meb, mc	
	Description	Operating voltage range	Part No.	Type	
	For plug socket with cable KMEB and plug socket MSSD-EB	12 ... 24 V DC	151717	MEB-LD-12-24DC	
		230 V DC/AC ±10%	151718	MEB-LD-230AC	
	For connecting cable KMC and plug socket MSSD-C	12 ... 24 V DC	19145	MC-LD-12-24DC	
		230 V DC/AC ±10%	19146	MC-LD-230AC	

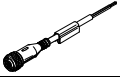
Ordering data – Connecting cable NEBU-M8				Technical data → Internet: nebu	
	Electrical connection	Number of wires	Cable length [m]	Part No.	Type
	M8x1, straight socket	3	2.5	★ 541333	NEBU-M8G3-K-2.5-LE3
			5	★ 541334	NEBU-M8G3-K-5-LE3
	M8x1, angled socket	3	2.5	★ 541338	NEBU-M8W3-K-2.5-LE3
			5	★ 541341	NEBU-M8W3-K-5-LE3

Ordering data – Connecting cable NEBU-M12				Technical data → Internet: nebu	
	Electrical connection	Number of wires	Cable length [m]	Part No.	Type
	M12x1, straight socket	4	2.5	★ 550326	NEBU-M12G5-K-2.5-LE4
			5	★ 541328	NEBU-M12G5-K-5-LE4
	M12x1, angled socket	4	2.5	550325	NEBU-M12W5-K-2.5-LE4
			5	541329	NEBU-M12W5-K-5-LE4

Ordering data – Sensor socket SIE-GD			Technical data → Internet: sie-gd	
	Electrical connection		Part No.	Type
	M12x1, 4-pin		18494	SIE-GD

Ordering data – Angled socket SIE-WD			Technical data → Internet: sie-wd	
	Electrical connection		Part No.	Type
	M12x1, 4-pin		12956	SIE-WD-TR

Ordering data – Pressure gauge MA						
	Nominal size	Pneumatic connection	Display range		Part No.	Type
			[bar]	[psi]		
	Pressure gauge MA, EN 837-1					
	40	R $\frac{1}{4}$	0 ... 16	0 ... 232	187080	MA-40-16-R$\frac{1}{4}$-EN
		G $\frac{1}{4}$	0 ... 16	0 ... 232	183901	MA-40-16-G$\frac{1}{4}$-EN
	Pressure gauge MA, EN 837-1, with red/green range					
50	R $\frac{1}{4}$	0 ... 16	–	525729	MA-50-16-R$\frac{1}{4}$-E-RG	

Festo core product range

- ★ Generally ready for shipping ex works in 24 hours
- ☆ Generally ready for shipping ex works in 5 days