

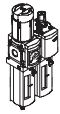

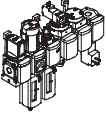



Service units MSB-FRC, MS series



Service units MSB-FRC, MS series

Product range overview – MS series service units

Type	Size	Pneumatic connection in housing	Connecting plate	Pressure regulation range [bar]						Grade of filtration [µm]				
				0.05	0.05	0.1	0.3	0.1	0.5					
				... 0.7	... 2.5	... 4	... 7	... 12	... 16	0.01	1	5	40	
Code			AG...	D2	D4	D5	D6	D7	D8	A	B	C	E	
Service units														
MSB-FRC		4	G1/8, G1/4	G1/8, G1/4, G3/8	-	-	-	■	■	-	-	-	■	■
		6	G1/4, G3/8, G1/2	G1/4, G3/8, G1/2, G3/4	-	-	-	■	■	-	-	-	■	■
		9	-											
		12	-											
Service unit combinations (further variants can be ordered using the configurator → Internet: msb4, msb6 or msb9)														
MSB		4	G1/4	G1/8, G1/4, G3/8	-	-	-	■	■	-	-	-	■	■
		6	G1/2	G1/4, G3/8, G1/2, G3/4	-	-	-	■	■	-	-	-	■	■
		9	-											
		12	-											
Individual devices														
Filter regulators MS-LFR		4	G1/8, G1/4	G1/8, G1/4, G3/8	-	-	■	■	■	-	-	-	■	■
		6	G1/4, G3/8, G1/2	G1/4, G3/8, G1/2, G3/4	-	-	■	■	■	■	-	-	■	■
		9	-											
		12	-	G1, G1 1/4, G1 1/2, G2	-	-	-	■	■	■	-	-	■	■
Filters MS-LF		4	G1/8, G1/4	G1/8, G1/4, G3/8	-	-	-	-	-	-	-	-	■	■
		6	G1/4, G3/8, G1/2	G1/4, G3/8, G1/2, G3/4	-	-	-	-	-	-	-	-	■	■
		9	-											
		12	-	G1, G1 1/4, G1 1/2, G2	-	-	-	-	-	-	-	-	-	■
Fine and micro filters MS-LFM		4	G1/8, G1/4	G1/8, G1/4, G3/8	-	-	-	-	-	-	■	■	-	-
		6	G1/4, G3/8, G1/2	G1/4, G3/8, G1/2, G3/4	-	-	-	-	-	-	■	■	-	-
		9	G3/4, G1	G1/2, G3/4, G1, G1 1/4, G1 1/2	-	-	-	-	-	-	■	■	-	-
		12	-	G1, G1 1/4, G1 1/2, G2	-	-	-	-	-	-	■	■	-	-
Activated carbon filters MS-LFX		4	G1/8, G1/4	G1/8, G1/4, G3/8	-	-	-	-	-	-	-	-	-	-
		6	G1/4, G3/8, G1/2	G1/4, G3/8, G1/2, G3/4	-	-	-	-	-	-	-	-	-	-
		9	G3/4, G1	G1/2, G3/4, G1, G1 1/4, G1 1/2	-	-	-	-	-	-	-	-	-	-
		12	-	G1, G1 1/4, G1 1/2, G2	-	-	-	-	-	-	-	-	-	-
Water separators MS-LWS		4	-											
		6	G1/4, G3/8, G1/2	G1/4, G3/8, G1/2, G3/4	-	-	-	-	-	-	-	-	-	-
		9	-											
		12	-											

Service units MSB-FRC, MS series

Product range overview – MS series service units

Type	Size	Bowl guard		Condensate drains				Pressure indicator					Actuator lock		Options		→ Page/ Internet
		Plastic bowl with plastic bowl guard	Metal bowl	Manual rotary	Semi-automatic	Fully automatic	External, fully automatic, electrical	Cover plate (without pressure gauge)	Integrated MS pressure gauge	Adapter plate for EN pressure gauge G1/8	Adapter plate for EN pressure gauge G1/4	Pressure sensor	Rotary knob, lockable	Rotary knob, long	Silencer	Flow direction from right to left	
Code		R	U	M	H	V	E...	VS	AG	A8	A4	AD...	AS	LD	S	Z	
Service units																	
MSB-FRC	4	■	-	■	-	■	-	-	■	-	-	-	■	-	-	■	8
	6	■	■	■	-	■	-	-	■	-	-	-	■	-	-	■	8
	9	-	-	-	-	-	-	-	-	-	-	-	-	-	-	-	-
	12	-	-	-	-	-	-	-	-	-	-	-	-	-	-	-	-
Service unit combinations																	
MSB	4	■	■	■	-	■	-	-	■	-	-	-	■	-	-	■	msb4
	6	■	■	■	-	■	-	-	■	-	-	-	■	-	-	■	msb6
	9	-	-	-	-	-	-	-	-	-	-	-	-	-	-	-	-
	12	-	-	-	-	-	-	-	-	-	-	-	-	-	-	-	-
Individual devices																	
Filter regulators MS-LFR	4	■	■	■	■	■	-	■	■	■	■	■	■	■	-	■	ms4-lfr
	6	■	■	■	■	■	■	■	■	-	■	■	■	■	-	■	ms6-lfr
	9	-	-	-	-	-	-	-	-	-	-	-	-	-	-	-	-
	12	-	■	■	-	■	■	■	■	-	■	-	■	■	-	■	ms12-lfr
Filters MS-LF	4	■	■	■	■	■	-	-	-	-	-	-	-	-	-	■	ms4-lf
	6	■	■	■	■	■	■	-	-	-	-	-	-	-	-	■	ms6-lf
	9	-	-	-	-	-	-	-	-	-	-	-	-	-	-	-	-
	12	-	■	■	-	■	■	-	-	-	-	-	-	-	-	■	ms12-lf
Fine and micro filters MS-LFM	4	■	■	■	■	■	-	-	-	-	-	-	-	-	-	■	ms4-lfm
	6	■	■	■	■	■	■	-	-	-	-	-	-	-	-	■	ms6-lfm
	9	-	■	■	-	■	■	-	-	-	-	-	-	-	-	■	ms9-lfm
	12	-	■	■	-	■	■	-	-	-	-	-	-	-	-	■	ms12-lfm
Activated carbon filters MS-LFX	4	■	■	-	-	-	-	-	-	-	-	-	-	-	-	■	ms4-lfx
	6	■	■	-	-	-	-	-	-	-	-	-	-	-	-	■	ms6-lfx
	9	-	■	-	-	-	-	-	-	-	-	-	-	-	-	■	ms9-lfx
	12	-	■	-	-	-	-	-	-	-	-	-	-	-	-	■	ms12-lfx
Water separators MS-LWS	4	-	-	-	-	-	-	-	-	-	-	-	-	-	-	-	-
	6	-	■	-	-	■	■	-	-	-	-	-	-	-	-	■	ms6-lws
	9	-	-	-	-	-	-	-	-	-	-	-	-	-	-	-	-
	12	-	-	-	-	-	-	-	-	-	-	-	-	-	-	-	-

Service units MSB-FRC, MS series

Product range overview – MS series service units



Type	Size	Pneumatic connection in housing	Connecting plate	Pressure regulation range [bar]						Supply voltage			
				0.05 ... 0.7	0.05 ... 2.5	0.1 ... 4	0.3 ... 7	0.1 ... 12	0.5 ... 16	24 V DC, connection pattern to EN 175301	24 V DC, connection pattern M12 to DESINA	110 V AC, connection pattern to EN 175301	230 V AC, connection pattern to EN 175301
Code			AG...	D2	D4	D5	D6	D7	D8	V24	V24P	V110	V230
Individual devices													
Pressure regulators MS-LR		4	G1/8, G1/4	G1/8, G1/4, G3/8	-	-	■	■	■	-	-	-	-
		6	G1/4, G3/8, G1/2	G1/4, G3/8, G1/2, G3/4	-	-	■	■	■	■	-	-	-
		9	-										
		12	-	G1, G1 1/4, G1 1/2, G2	-	-	-	■	■	■	-	-	-
Pressure regulators MS-LRB		4	G1/4	G1/8, G1/4, G3/8	-	-	■	■	■	-	-	-	-
		6	G1/2	G1/4, G3/8, G1/2, G3/4	-	-	■	■	■	■	-	-	-
		9	-										
		12	-										
Precision pressure regulators MS-LRP		4	-										
		6	G1/4, G3/8, G1/2	G1/4, G3/8, G1/2, G3/4	■	■	■	-	■	-	-	-	-
		9	-										
		12	-										
Precision pressure regulators MS-LRPB		4	-										
		6	G1/2	G1/4, G3/8, G1/2, G3/4	■	■	■	-	■	-	-	-	-
		9	-										
		12	-										
Electrical pressure regulators MS-LRE		4	-										
		6	G1/4, G3/8, G1/2	G1/4, G3/8, G1/2, G3/4	-	-	■	■	■	■	-	-	-
		9	-										
		12	-										
Lubricators MS-LOE		4	G1/8, G1/4	G1/8, G1/4, G3/8	-	-	-	-	-	-	-	-	-
		6	G1/4, G3/8, G1/2	G1/4, G3/8, G1/2, G3/4	-	-	-	-	-	-	-	-	-
		9	-										
		12	-	G1, G1 1/4, G1 1/2, G2	-	-	-	-	-	-	-	-	-
Electrical on-off valves MS-EM(1)		4	G1/8, G1/4	G1/8, G1/4, G3/8	-	-	-	-	-	-	-	-	-
		6	G1/4, G3/8, G1/2	G1/4, G3/8, G1/2, G3/4	-	-	-	-	-	-	-	-	-
		9	-										
		12	-	G1, G1 1/4, G1 1/2, G2	-	-	-	-	-	-	-	-	-
Electrical on-off valves MS-EE		4	G1/8, G1/4	G1/8, G1/4, G3/8	-	-	-	-	-	-	■	-	■
		6	G1/4, G3/8, G1/2	G1/4, G3/8, G1/2, G3/4	-	-	-	-	-	-	■	-	■
		9	-										
		12	-	G1, G1 1/4, G1 1/2, G2	-	-	-	-	-	-	■	■	■
Electrical soft-start valves MS-DL		4	G1/8, G1/4	G1/8, G1/4, G3/8	-	-	-	-	-	-	-	-	-
		6	G1/4, G3/8, G1/2	G1/4, G3/8, G1/2, G3/4	-	-	-	-	-	-	-	-	-
		9	-										
		12	-	G1, G1 1/4, G1 1/2, G2	-	-	-	-	-	-	-	-	-
Electrical soft-start valves MS-DE		4	G1/8, G1/4	G1/8, G1/4, G3/8	-	-	-	-	-	-	■	-	■
		6	G1/4, G3/8, G1/2	G1/4, G3/8, G1/2, G3/4	-	-	-	-	-	-	■	-	■
		9	-										
		12	-	G1, G1 1/4, G1 1/2, G2	-	-	-	-	-	-	■	■	■
Soft start and exhaust valves MS-SV		4	-										
		6	G1/2	G1/4, G3/8, G1/2, G3/4	-	-	-	-	-	-	■	-	-
		9	-										
		12	-										

Service units MSB-FRC, MS series





Product range overview – MS series service units

Type	Size	Bowl guard		Pressure indicator				Actuator lock		Options		→ Page/ Internet	
		Plastic bowl with plastic bowl guard	Metal bowl	Cover plate (without pressure gauge)	Integrated MS pressure gauge	Adapter plate for EN pressure gauge G1/8	Adapter plate for EN pressure gauge G1/4	Pressure sensor	Rotary knob, lockable	Rotary knob, long	Silencer		Flow direction from right to left
Code		R	U	VS	AG	A8	A4	AD...	AS	LD	S	Z	
Individual devices													
Pressure regulators MS-LR	4	-	-	■	■	■	■	■	■	■	-	■	ms4-lr
	6	-	-	■	■	-	■	■	■	■	-	■	ms6-lr
	9	-	-	-	-	-	-	-	-	-	-	-	-
	12	-	-	■	■	-	■	-	■	■	-	■	ms12-lr
Pressure regulators MS-LRB	4	-	-	■	■	■	■	■	■	■	-	■	ms4-lrb
	6	-	-	■	■	-	■	■	■	■	-	■	ms6-lrb
	9	-	-	-	-	-	-	-	-	-	-	-	-
	12	-	-	-	-	-	-	-	-	-	-	-	-
Precision pressure regulators MS-LRP	4	-	-	-	-	-	-	-	-	-	-	-	-
	6	-	-	■	-	■	■	■	■	■	-	■	ms6-lrp
	9	-	-	-	-	-	-	-	-	-	-	-	-
	12	-	-	-	-	-	-	-	-	-	-	-	-
Precision pressure regulators MS-LRPB	4	-	-	-	-	-	-	-	-	-	-	-	-
	6	-	-	■	-	■	■	■	■	■	-	■	ms6-lrpb
	9	-	-	-	-	-	-	-	-	-	-	-	-
	12	-	-	-	-	-	-	-	-	-	-	-	-
Electrical pressure regulators MS-LRE	4	-	-	-	-	-	-	-	-	-	-	-	-
	6	-	-	■	■	-	■	-	-	-	-	■	ms6-lre
	9	-	-	-	-	-	-	-	-	-	-	-	-
	12	-	-	-	-	-	-	-	-	-	-	-	-
Lubricators MS-LOE	4	■	■	-	-	-	-	-	-	-	-	■	ms4-loe
	6	■	■	-	-	-	-	-	-	-	-	■	ms6-loe
	9	-	-	-	-	-	-	-	-	-	-	-	-
	12	-	■	-	-	-	-	-	-	-	-	■	ms12-loe
Electrical on-off valves MS-EM(1)	4	-	-	■	■	■	■	■	-	-	■	■	ms4-em1
	6	-	-	■	■	-	■	■	-	-	■	■	ms6-em1
	9	-	-	-	-	-	-	-	-	-	-	-	-
	12	-	-	■	■	-	■	-	-	-	■	■	ms12-em
Electrical on-off valves MS-EE	4	-	-	■	■	■	■	■	-	-	■	■	ms4-ee
	6	-	-	■	■	-	■	■	-	-	■	■	ms6-ee
	9	-	-	-	-	-	-	-	-	-	-	-	-
	12	-	-	■	■	-	■	-	-	-	■	■	ms12-ee
Electrical soft-start valves MS-DL	4	-	-	■	■	■	■	■	-	-	-	■	ms4-dl
	6	-	-	■	■	-	■	■	-	-	-	■	ms6-dl
	9	-	-	-	-	-	-	-	-	-	-	-	-
	12	-	-	■	■	-	■	-	-	-	-	■	ms12-dl
Electrical soft-start valves MS-DE	4	-	-	■	■	■	■	■	-	-	-	■	ms4-de
	6	-	-	■	■	-	■	■	-	-	-	■	ms6-de
	9	-	-	-	-	-	-	-	-	-	-	-	-
	12	-	-	■	■	-	■	-	-	-	-	■	ms12-de
Soft start and exhaust valves MS-SV	4	-	-	-	-	-	-	-	-	-	-	-	-
	6	-	-	■	■	-	■	■	-	-	■	■	ms6-sv
	9	-	-	-	-	-	-	-	-	-	-	-	-
	12	-	-	-	-	-	-	-	-	-	-	-	-

Service units MSB-FRC, MS series

Product range overview – MS series service units



Type	Size	Pneumatic connection in housing	Connecting plate	Pressure regulation range [bar]				Supply voltage				
				0.1 ... 4	0.3 ... 7	0.1 ... 12	0.5 ... 16	24 V DC, connection pattern to EN 175301	24 V DC, connection pattern M12 to DESINA	110 V AC, connection pattern to EN 175301	230 V AC, connection pattern to EN 175301	
Code			AG...	D5	D6	D7	D8	V24	V24P	V110	V230	
Individual devices												
Membrane air dryers MS-LDM1		4	G1/8, G1/4	G1/8, G1/4, G3/8	-	-	-	-	-	-	-	-
		6	G1/4, G3/8, G1/2	G1/4, G3/8, G1/2, G3/4	-	-	-	-	-	-	-	-
		9	-									
		12	-									
Branching modules MS-FRM		4	G1/8, G1/4	G1/8, G1/4, G3/8	-	-	-	-	-	-	-	-
		6	G1/4, G3/8, G1/2	G1/4, G3/8, G1/2, G3/4	-	-	-	-	-	-	-	-
		9	-									
		12	-	G1, G1 1/4, G1 1/2, G2	-	-	-	-	-	-	-	-
Distributor blocks MS-FRM-FRZ		4	G1/4	-	-	-	-	-	-	-	-	-
		6	G1/2	-	-	-	-	-	-	-	-	-
		9	-									
		12	-									
Flow sensors MS-SFE		4	-									
		6	G1/2	G1/2	-	-	-	-	-	-	-	-
		9	-									
		12	-									
Flow sensors SFAM		4	-									
		6	G1/2	G1/2	-	-	-	-	-	-	-	-
		9	-									
		12	-									

Service units MSB-FRC, MS series

Product range overview – MS series service units

Type	Size	Bowl guard		Pressure indicator				Switch output		Options		→ Page/ Internet	
		Plastic bowl with plastic bowl guard	Metal bowl	Cover plate (without pressure gauge)	Integrated MS pressure gauge	Adapter plate for EN pressure gauge G1/8	Adapter plate for EN pressure gauge G1/4	Pressure sensor	2x PNP	2x NPN	Silencer		Flow direction from right to left
Code		R	U	VS	AG	A8	A4	AD...	P2/2S	N2/2S	S	Z/R	
Individual devices													
Membrane air dryers MS-LDM1	4	-	■	-	-	-	-	-	-	-	-	■	ms4-ldm1
	6	-	■	-	-	-	-	-	-	-	-	■	ms6-ldm1
	9	-	-	-	-	-	-	-	-	-	-	-	-
	12	-	-	-	-	-	-	-	-	-	-	-	-
Branching modules MS-FRM	4	-	-	■	■	■	■	■	-	-	-	■	ms4-frm
	6	-	-	■	■	-	■	■	-	-	-	■	ms6-frm
	9	-	-	-	-	-	-	-	-	-	-	-	-
	12	-	-	■	-	-	-	-	-	-	-	-	ms12-frm
Distributor blocks MS-FRM-FRZ	4	-	-	-	-	-	-	-	-	-	-	■	ms4-frm
	6	-	-	-	-	-	-	-	-	-	-	■	ms6-frm
	9	-	-	-	-	-	-	-	-	-	-	-	-
	12	-	-	-	-	-	-	-	-	-	-	-	-
Flow sensors MS-SFE	4	-	-	-	-	-	-	-	-	-	-	-	-
	6	-	-	-	-	-	-	-	■	■	-	■ ¹⁾	ms6-sfe
	9	-	-	-	-	-	-	-	-	-	-	-	-
	12	-	-	-	-	-	-	-	-	-	-	-	-
Flow sensors SFAM	4	-	-	-	-	-	-	-	-	-	-	-	-
	6	-	-	-	-	-	-	-	■	■	-	■	sfam
	9	-	-	-	-	-	-	-	-	-	-	-	-
	12	-	-	-	-	-	-	-	-	-	-	-	-

1) Can only be ordered using the configurator → Internet: ms6-sfe

Service units MSB4/MSB6-FRC, MS series

Peripherals overview

FESTO

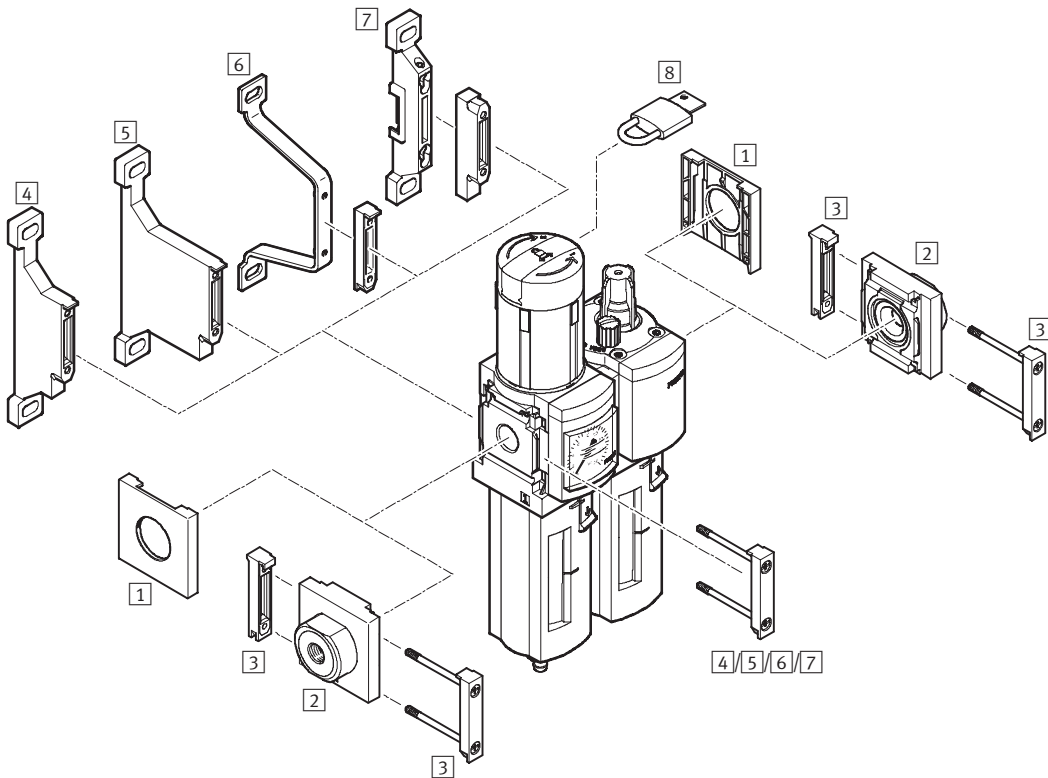

Mounting attachments and accessories		→ Page/Internet
1	Cover cap MS4/6-END	ms4-end, ms6-end
2	Connecting plate MS4/6-AG...	ms4-ag, ms6-ag
3	Module connector MS4/6-MV	ms4-mv, ms6-mv
4	Mounting bracket MS4/6-WP	ms4-wp, ms6-wp
5	Mounting bracket MS4/6-WPB	ms4-wp, ms6-wp
6	Mounting bracket MS4/6-WPE	ms4-wp, ms6-wp
7	Mounting bracket MS4/6-WPM	ms4-wp, ms6-wp
8	Padlock LRVS-D	17

Service units MSB4/MSB6-FRC, MS series

Type codes

MSB	6	-	3/8	-	FRC2:J6	M1
Series						
MSB	Service unit					
Size						
4	Grid dimension 40 mm					
6	Grid dimension 62 mm					
Pneumatic connection						
MSB4						
1/8	Thread G1/8					
1/4	Thread G1/4					
MSB6						
1/4	Thread G1/4					
3/8	Thread G3/8					
1/2	Thread G1/2					
Service unit consisting of:						
<ul style="list-style-type: none"> • Filter regulator with pressure gauge, lockable standard type rotary knob • Lubricator 						
Pressure regulation range 0.3 ... 7 bar						
Plastic bowl guard						
FRC3:J7	Grade of filtration 5 µm, manual rotary condensate drain					
FRC4:J8	Grade of filtration 5 µm, fully automatic condensate drain					
FRC1:J5	Grade of filtration 40 µm, manual rotary condensate drain					
FRC2:J6	Grade of filtration 40 µm, fully automatic condensate drain					
Pressure regulation range 0.5 ... 12 bar						
Plastic bowl guard						
FRC7:J3	Grade of filtration 5 µm, manual rotary condensate drain					
FRC8:J4	Grade of filtration 5 µm, fully automatic condensate drain					
FRC5:J1	Grade of filtration 40 µm, manual rotary condensate drain					
FRC6:J2	Grade of filtration 40 µm, fully automatic condensate drain					
Metal bowl						
FRC11:J9	Grade of filtration 5 µm, manual rotary condensate drain					
FRC12:J10	Grade of filtration 5 µm, fully automatic condensate drain					
FRC9:J11	Grade of filtration 40 µm, manual rotary condensate drain					
FRC10:J12	Grade of filtration 40 µm, fully automatic condensate drain					
Lubricators						
M1	Plastic bowl guard					
M2	Metal bowl					

Service units MSB4/MSB6-FRC, MS series

Technical data

FESTO

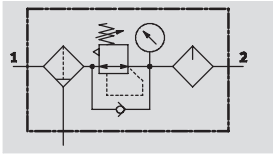

Function

With condensate drain
manual rotary

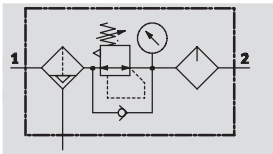

With condensate drain
fully automatic



-  Flow rate
800 ... 4,800 l/min
-  Temperature range
-10 ... +60 °C
-  Input pressure
1.5 ... 20 bar



- Filter, regulator and lubricator function in a single unit
- High flow rate and highly efficient removal of contaminants
- Good regulating characteristics with minimal pressure hysteresis
- Setting values are secured by locking the rotary knob
- Lockable rotary knob
- Two pressure regulation ranges: 0.3 ... 7 bar and 0.5 ... 12 bar
- With manual or integrated, fully automatic condensate drain
- Choice of filter cartridges: 5 µm or 40 µm
- New filter cartridges → 17, Festo special oil → 17

General technical data					
Size	MSB4		MSB6		
Pneumatic connection 1, 2	G $\frac{1}{8}$	G $\frac{1}{4}$	G $\frac{1}{4}$	G $\frac{3}{8}$	G $\frac{1}{2}$
Design	Filter regulator with pressure gauge Proportional standard mist lubricator				
Regulating function	With primary pressure compensation With secondary venting With return flow function Output pressure constant				
Type of mounting	Via accessories				
Assembly position	Vertical $\pm 5^\circ$				
Grade of filtration [µm]	5 (air purity class at the output 3.7.- to DIN ISO 8573-1) 40 (air purity class at the output 5.7.- to DIN ISO 8573-1)				
Bowl guard	Plastic bowl guard		Plastic bowl guard		
	-		Metal bowl guard		
Condensate drains	Manual rotary Fully automatic				
Actuator lock	Rotary knob with integrated lock				
Pressure regulation range [bar]	0.3 ... 7 0.5 ... 12				
Pressure indicator	With pressure gauge				

-  Note: This product conforms with the ISO 1179-1 standard and the ISO 228-1 standard.

Service units MSB4/MSB6-FRC, MS series

Technical data

Standard nominal flow rate $q_{nN}^{1)}$ [l/min]						
Size	MSB4			MSB6		
Pneumatic connection	G $\frac{1}{8}$	G $\frac{1}{4}$	G $\frac{1}{4}$	G $\frac{3}{8}$	G $\frac{1}{2}$	G $\frac{1}{2}$
Pressure regulation range 0.3... 7 bar						
Grade of filtration	5 μ m	900	1,300	2,000	4,400	4,600
	40 μ m	950	1,400	2,100	4,600	4,800
Pressure regulation range 0.5... 12 bar						
Grade of filtration	5 μ m	800	850	1,700	3,400	3,600
	40 μ m	850	900	1,900	3,500	3,700

1) Measured at $p_1 = 10$ bar and $p_2 = 6$ bar, $\Delta p = 1$ bar.

Operating and environmental conditions				
Condensate drains		Manual rotary		Fully automatic
Size	MSB4	MSB6	MSB4	MSB6
Supply pressure [bar]	1.5 ... 14	1.5 ... 20	1.5 ... 12	1.5 ... 12
Operating medium	Compressed air			
Ambient temperature [°C]	-10 ... +60		+5 ... +60	
Temperature of medium [°C]	-10 ... +60		+5 ... +60	
Storage temperature [°C]	-10 ... +60		-10 ... +60	
Corrosion resistance	CRC ¹⁾	2		

1) Corrosion resistance class 2 according to Festo standard 940 070
 Components requiring moderate corrosion resistance. Externally visible parts with primarily decorative surface requirements which are in direct contact with a normal industrial environment or media such as coolants or lubricating agents.

Weights [g]		
Size	MSB4	MSB6
With plastic bowl guard	500	1,495
With metal bowl guard	-	1,713

Materials

Sectional view

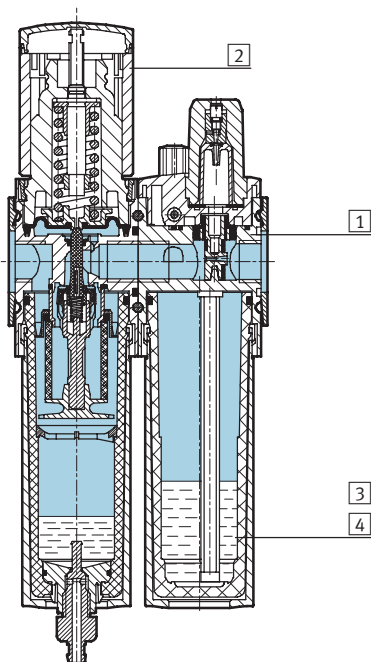

Service unit		
1	Body	Die-cast aluminium
2	Regulating knob	Polyamide/polyacetate
3	Plastic bowl guard	Polycarbonate
4	Metal bowl guard	Wrought aluminium alloy
-	Seals	Nitrile rubber

Service units MSB4/MSB6-FRC, MS series

Technical data



Standard flow rate q_n as a function of output pressure p_2

Pressure regulation range 0.3 ... 7 bar Grade of filtration 5 μm

MSB4-1/8

Primary pressure $p_1 = 10$ bar

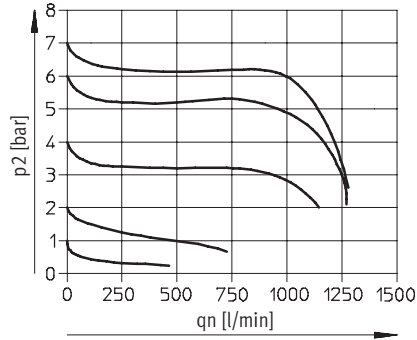

Grade of filtration 40 μm

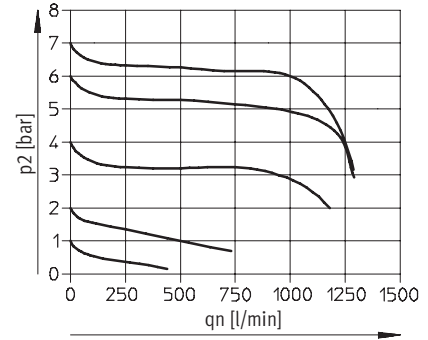

MSB4-1/4

Primary pressure $p_1 = 10$ bar

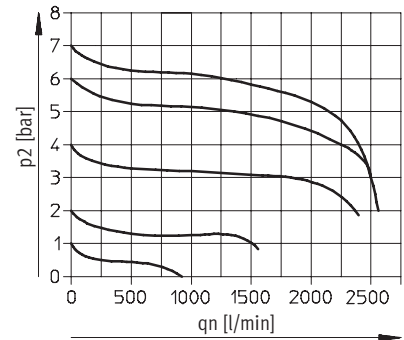
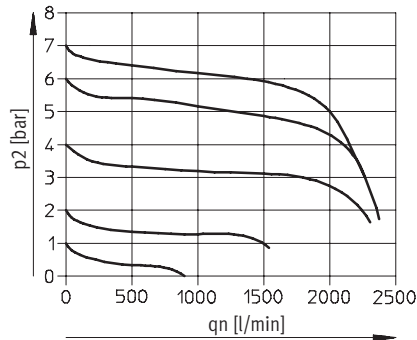

Pressure regulation range 0.5 ... 12 bar Grade of filtration 5 μm

MSB4-1/8

Primary pressure $p_1 = 10$ bar

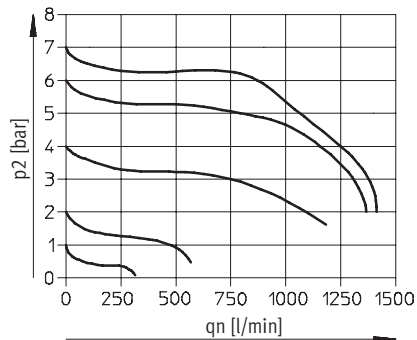

Grade of filtration 40 μm

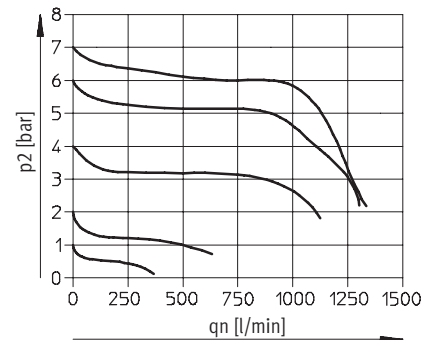

MSB4-1/4

Primary pressure $p_1 = 10$ bar

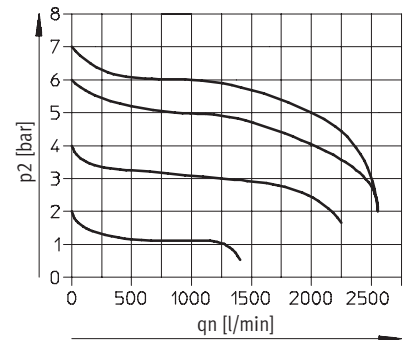
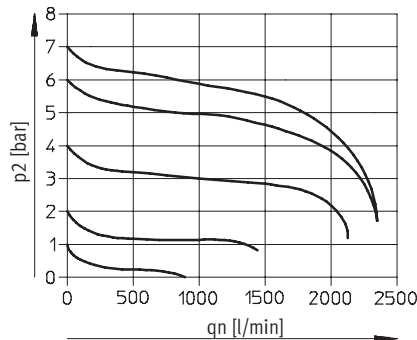

Service units MSB4/MSB6-FRC, MS series

Technical data

Standard flow rate q_n as a function of output pressure p_2

Pressure regulation range 0.3 ... 7 bar

Grade of filtration 5 μm

Grade of filtration 40 μm

MSB6-1/4

Primary pressure $p_1 = 10$ bar

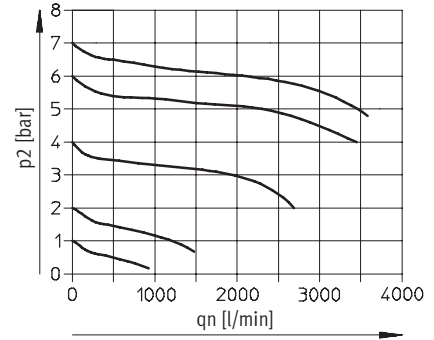
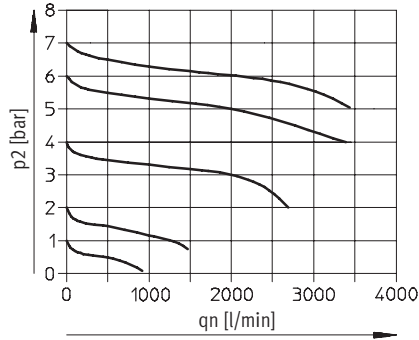

MSB6-3/8

Primary pressure $p_1 = 10$ bar

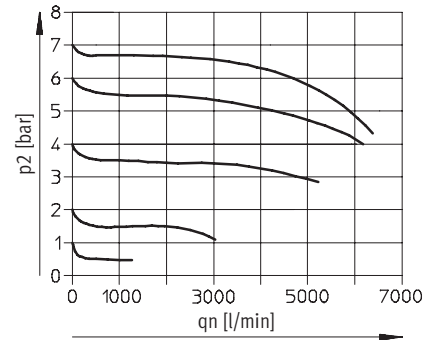
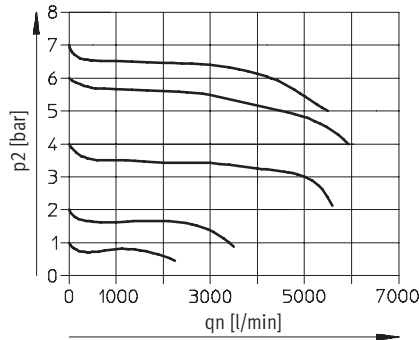

MSB6-1/2

Primary pressure $p_1 = 10$ bar

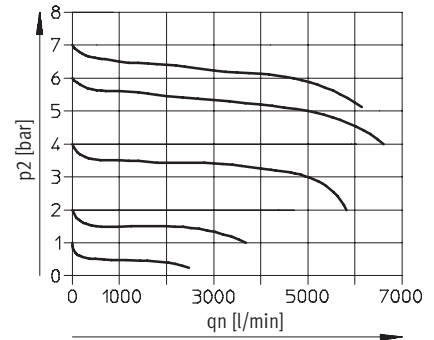
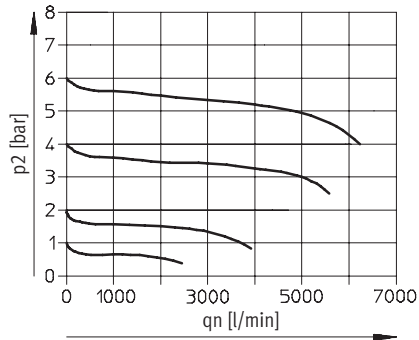

Service units MSB4/MSB6-FRC, MS series

Technical data

Standard flow rate q_n as a function of output pressure p_2

Pressure regulation range 0.5 ... 12 bar Grade of filtration 5 μm

MSB6-1/4

Primary pressure $p_1 = 10$ bar

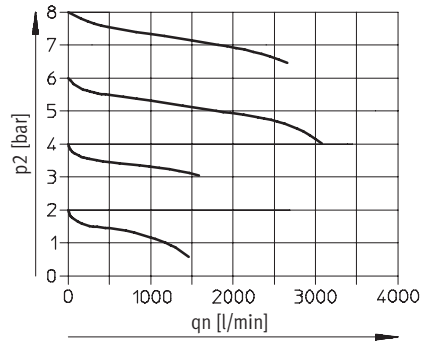

Grade of filtration 40 μm

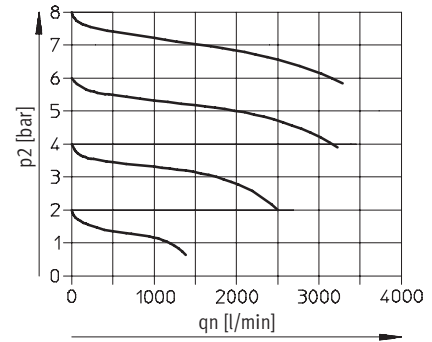

MSB6-3/8

Primary pressure $p_1 = 10$ bar

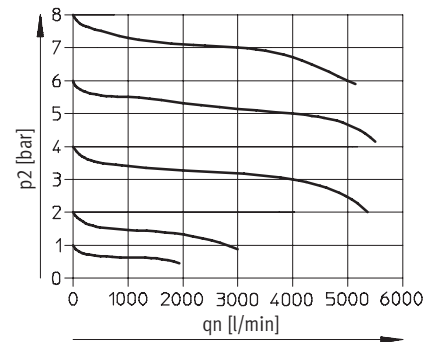
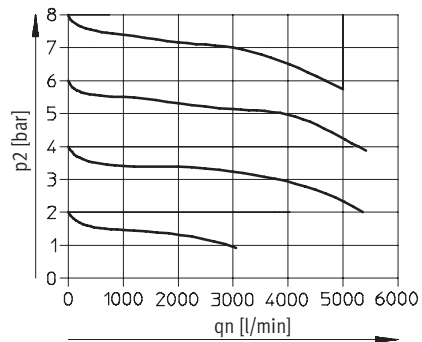

MSB6-1/2

Primary pressure $p_1 = 10$ bar

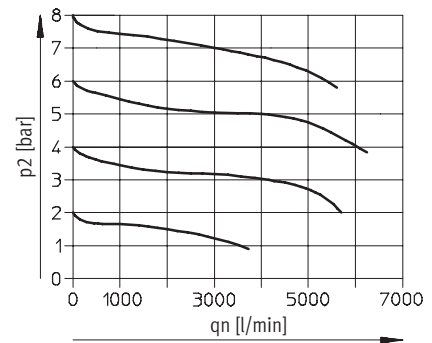
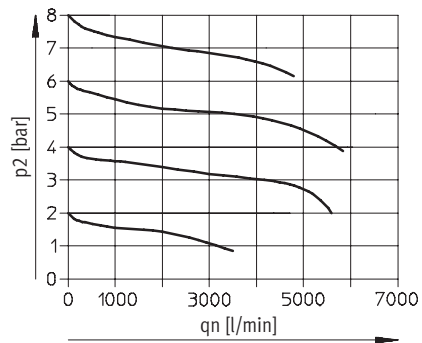

Service units MSB4/MSB6-FRC, MS series

Technical data

FESTO

Dimensions

Download CAD data → www.festo.com

With pressure gauge, display unit [bar]

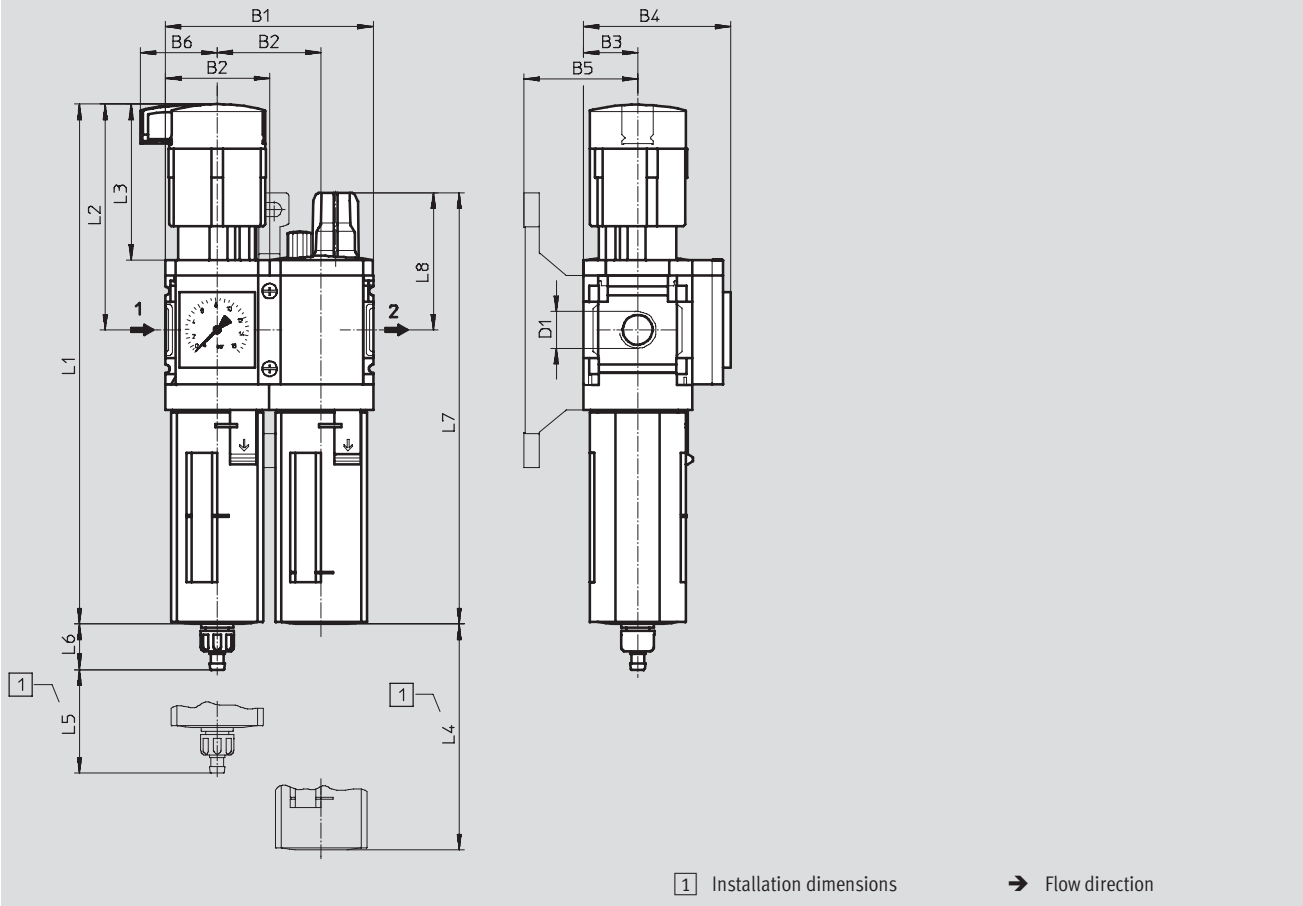

Type	B1	B2	B3	B4	B5	B6	D1	L1	L2	L3	L4	L5	L6 Condensate drain		L7	L8
													manual rotary	fully auto- matic		
MSB4-1/8	80.4	40.2	21	57	44	29.7	G1/8	201	87	60	80	25	17.7	20.4	167	53
MSB4-1/4							G1/4									
MSB6-1/4	124	62	31	77	54	38.8	G1/4	284.8	134.5	95.5	130	68	15.8	18.5	215.3	65.6
MSB6-3/8							G3/8									
MSB6-1/2							G1/2									

- | - Note: This product conforms with the ISO 1179-1 standard and the ISO 228-1 standard.

Service units MSB4/MSB6-FRC, MS series

FESTO

Technical data

Ordering data						
Pressure regulation range 0.3 ... 7 bar						
Size	Condensate drain	Connection	Grade of filtration 5 µm		Grade of filtration 40 µm	
			Part No.	Type	Part No.	Type
Plastic bowl guard						
MSB4	manual rotary	G $\frac{1}{8}$	531129	MSB4- $\frac{1}{8}$ -FRC3:J7M1	531125	MSB4- $\frac{1}{8}$ -FRC1:J5M1
		G $\frac{1}{4}$	531113	MSB4- $\frac{1}{4}$ -FRC3:J7M1	531109	MSB4- $\frac{1}{4}$ -FRC1:J5M1
	fully automatic	G $\frac{1}{8}$	531131	MSB4- $\frac{1}{8}$ -FRC4:J8M1	531127	MSB4- $\frac{1}{8}$ -FRC2:J6M1
		G $\frac{1}{4}$	531115	MSB4- $\frac{1}{4}$ -FRC4:J8M1	531111	MSB4- $\frac{1}{4}$ -FRC2:J6M1
MSB6	manual rotary	G $\frac{1}{4}$	530264	MSB6- $\frac{1}{4}$ -FRC3:J7M1	530254	MSB6- $\frac{1}{4}$ -FRC1:J5M1
		G $\frac{3}{8}$	530288	MSB6- $\frac{3}{8}$ -FRC3:J7M1	530278	MSB6- $\frac{3}{8}$ -FRC1:J5M1
		G $\frac{1}{2}$	530240	MSB6- $\frac{1}{2}$ -FRC3:J7M1	530230	MSB6- $\frac{1}{2}$ -FRC1:J5M1
	fully automatic	G $\frac{1}{4}$	530266	MSB6- $\frac{1}{4}$ -FRC4:J8M1	530262	MSB6- $\frac{1}{4}$ -FRC2:J6M1
		G $\frac{3}{8}$	530290	MSB6- $\frac{3}{8}$ -FRC4:J8M1	530286	MSB6- $\frac{3}{8}$ -FRC2:J6M1
		G $\frac{1}{2}$	530242	MSB6- $\frac{1}{2}$ -FRC4:J8M1	530238	MSB6- $\frac{1}{2}$ -FRC2:J6M1

Ordering data						
Pressure regulation range 0.5 ... 12 bar						
Size	Condensate drain	Connection	Grade of filtration 5 µm		Grade of filtration 40 µm	
			Part No.	Type	Part No.	Type
Plastic bowl guard						
MSB4	manual rotary	G $\frac{1}{8}$	531137	MSB4- $\frac{1}{8}$ -FRC7:J3M1	531133	MSB4- $\frac{1}{8}$ -FRC5:J1M1
		G $\frac{1}{4}$	531121	MSB4- $\frac{1}{4}$ -FRC7:J3M1	531117	MSB4- $\frac{1}{4}$ -FRC5:J1M1
	fully automatic	G $\frac{1}{8}$	531139	MSB4- $\frac{1}{8}$ -FRC8:J4M1	531135	MSB4- $\frac{1}{8}$ -FRC6:J2M1
		G $\frac{1}{4}$	531123	MSB4- $\frac{1}{4}$ -FRC8:J4M1	531119	MSB4- $\frac{1}{4}$ -FRC6:J2M1
MSB6	manual rotary	G $\frac{1}{4}$	530272	MSB6- $\frac{1}{4}$ -FRC7:J3M1	530268	MSB6- $\frac{1}{4}$ -FRC5:J1M1
		G $\frac{3}{8}$	530296	MSB6- $\frac{3}{8}$ -FRC7:J3M1	530292	MSB6- $\frac{3}{8}$ -FRC5:J1M1
		G $\frac{1}{2}$	530248	MSB6- $\frac{1}{2}$ -FRC7:J3M1	530244	MSB6- $\frac{1}{2}$ -FRC5:J1M1
	fully automatic	G $\frac{1}{4}$	530274	MSB6- $\frac{1}{4}$ -FRC8:J4M1	530270	MSB6- $\frac{1}{4}$ -FRC6:J2M1
		G $\frac{3}{8}$	530298	MSB6- $\frac{3}{8}$ -FRC8:J4M1	530294	MSB6- $\frac{3}{8}$ -FRC6:J2M1
		G $\frac{1}{2}$	530250	MSB6- $\frac{1}{2}$ -FRC8:J4M1	530246	MSB6- $\frac{1}{2}$ -FRC6:J2M1
Metal bowl						
MSB6	manual rotary	G $\frac{1}{4}$	530258	MSB6- $\frac{1}{4}$ -FRC11:J9M2	530276	MSB6- $\frac{1}{4}$ -FRC9:J11M2
		G $\frac{3}{8}$	530282	MSB6- $\frac{3}{8}$ -FRC11:J9M2	530300	MSB6- $\frac{3}{8}$ -FRC9:J11M2
		G $\frac{1}{2}$	530234	MSB6- $\frac{1}{2}$ -FRC11:J9M2	530252	MSB6- $\frac{1}{2}$ -FRC9:J11M2
	fully automatic	G $\frac{1}{4}$	530260	MSB6- $\frac{1}{4}$ -FRC12:J10M2	530256	MSB6- $\frac{1}{4}$ -FRC10:J12M2
		G $\frac{3}{8}$	530284	MSB6- $\frac{3}{8}$ -FRC12:J10M2	530280	MSB6- $\frac{3}{8}$ -FRC10:J12M2
		G $\frac{1}{2}$	530236	MSB6- $\frac{1}{2}$ -FRC12:J10M2	530232	MSB6- $\frac{1}{2}$ -FRC10:J12M2

Service units MSB-FRC, MS series

Accessories

Filter cartridges



Ordering data			
Size	Grade of filtration [µm]	Part No.	Type
MS4	5	534501	MS4-LFP-C
	40	534502	MS4-LFP-E
MS6	5	534499	MS6-LFP-C
	40	534500	MS6-LFP-E

Special oil



Ordering data			
Scope of delivery	Part No.	Type	
1 litre	152811	OFSW-32	

Ordering data – Padlock LRV5-D			
	Weight [g]	Part No.	Type
	120	193786	LRV5-D